

Oracle Identity Manager Integration Implementation Guide
Oracle FLEXCUBE Investor Servicing
Release 14.5.3.0.0
[February] [2022]



Table of Contents

| | |
|--|------------|
| 1. INTRODUCTION | 1-2 |
| 2. REQUIREMENTS/ PROBLEM STATEMENT | 2-1 |
| 3. PREREQUISITES..... | 3-1 |
| 3.1 SOFTWARE REQUIRED | 3-1 |
| 3.2 ORACLE FLEXCUBE COMPONENT REQUIRED | 3-2 |
| 4. SYSTEM DESCRIPTION | 4-1 |
| 4.1 ABOUT ORACLE IDENTITY MANAGER | 4-1 |
| 4.1.1 <i>Oracle Identity Manager System Components</i> | 4-1 |
| 4.2 INTEGRATION / DESIGN ARCHITECTURE..... | 4-4 |
| 4.2.1 <i>Provisioning Design Architecture</i> | 4-4 |
| 4.2.2 <i>Reconciliation Design Architecture</i> | 4-4 |
| 4.2.3 <i>Design Constraints</i> | 4-5 |
| 4.2.4 <i>Message Flow</i> | 4-5 |
| 5. INSTALLATION / CONFIGURATION..... | 5-1 |
| 5.1 ENVIRONMENT SETUP/ CONFIGURATIONS | 5-1 |
| 5.1.1 <i>Enabling SSL for Weblogic and OIM Server</i> | 5-1 |
| 5.1.2 <i>Enabling SSL on GTC Connector Server</i> | 5-6 |
| 5.1.3 <i>Configuring SSL Mode in Oracle Internet Directory</i> | 5-8 |
| 5.1.4 <i>OIM FLEXCUBE Adapter Setup</i> | 5-12 |
| 5.1.5 <i>Build GWEJB</i> | 5-25 |
| 5.1.6 <i>OIM Setup</i> | 5-25 |
| 5.1.7 <i>System Configurations</i> | 5-55 |
| 6. SOLUTION / USAGE GUIDELINES | 6-1 |
| 6.1 WORKING WITH OIM | 6-1 |
| 6.1.1 <i>Creating a user in Oracle FLEXCUBE through OIM</i> | 6-1 |
| 6.1.2 <i>Modifying a user in FCIS through OIM</i> | 6-8 |
| 6.1.3 <i>Disable/Remove Accounts in FCIS through OIM</i> | 6-11 |
| 6.1.4 <i>Enabling a Disabled user in FCIS through OIM</i> | 6-12 |
| 6.1.5 <i>Running Reconciliation in OIM</i> | 6-14 |
| 7. REFERENCE..... | 7-1 |
| 8. APPENDIX..... | 8-1 |
| 8.1 DATA SOURCE CREATION..... | 8-1 |

1. Introduction

For the purpose of centralized user provisioning FLEXCUBE is qualified with Oracle Identity Manager - Oracle® Fusion Middleware 11g Release 2 (11.1.2.3.0).

Scope

This document provides an understanding as to how centralized provisioning through OIM can be enabled for FCIS.

In addition to providing a background to the various components of the deployment, this document provides detailed steps as to how to install the various FCIS components required for the integration with OIM configuration in FCIS and Oracle Identity Manager to enable centralized provisioning.

Introduction to Oracle Identity Manager

Oracle Identity Manager is an identity management product that automates user provisioning, identity administration, and password management, integrated in a comprehensive workflow engine. It enables organizations to reduce Information Technology (IT) administration costs and improve security. Oracle identity manager achieves this by providing a centralized control mechanism to manage the entire life cycle of user identities and entitlements and to control user access to across all resources in the organization.

Advantage

Integrating FCIS with Oracle identity Manager provides capability for managing the entire life cycle of FCIS user identities through a centralized point provided by OIM in both scenario- FCIS without single sign on and FCIS with single sign on.

2. Requirements/ Problem Statement

The requirement is to integrate FCIS with Oracle Identity Manager for FCIS user provisioning and de-provisioning services with and without FCIS single sign on.

3. Prerequisites

3.1 Software Required

Oracle® Fusion Middleware 11g Release 2 (11.1.2.3.0)

Refer [Oracle Identity Manager Document for Installation and configuration of Oracle Identity Manager](#).

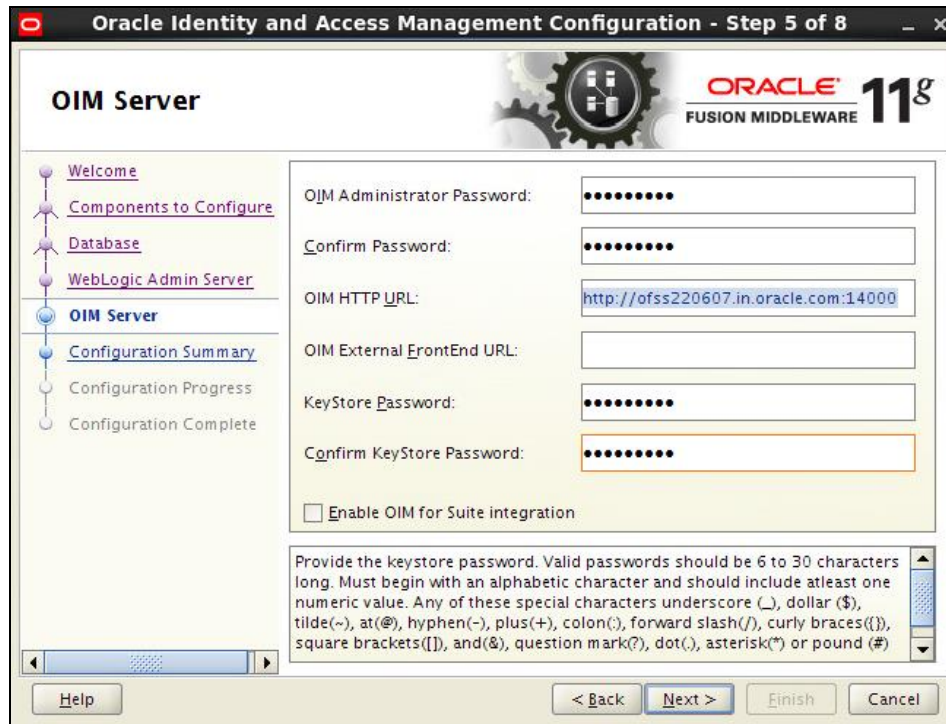

Note *: To get the Keystore Password in the above screen while configuring OIM Console, you should have only Weblogic Admin Server, OIM Server and SOA Server in this OIM Domain. Based on that the below keystore will be created with store password

<Domain_home>/config/fmwconfig/default-keystore.

- Oracle Internet Directory Connector 11.1.1.6.0
- Refer the below sections:
 - [Installation of Oracle Internet Directory Connector \(Section 2.2.1.1, 2.2.1.2 & 2.3.1.1\)](#)
 - Connector by default will be available with Oracle Identity and Access Management Suite.

The path will be as follows:

<Oracle_Middleware>/<OIM_HOME>/connectors/oid

For example:

Linux: /app/oracle/Middleware/Oracle_IDM1/connectors/oid

Windows: C:\apps\oracle\Middleware\Oracle_IDM1\connectors\oid

The above directory <oid> has to be copied into

<Oracle_Middleware>/<OIM_HOME>/server/ConnectorDefaultDirectory

> [Configuring Oracle Identity Manager Design Console](#)

3.2 **Oracle FLEXCUBE Component Required**

Oracle FLEXCUBE Gateway EJB

4. System Description

4.1 About Oracle Identity Manager

Oracle Identity Manager is an identity management product that automates user provisioning, identity administration, and password management, integrated in a comprehensive workflow engine. Key features of Oracle Identity Manager include password management, workflow and policy management, identity reconciliation, reporting and auditing, and extensibility through adapters.

4.1.1 Oracle Identity Manager System Components

Oracle Identity Manager is built on an enterprise-class, modular architecture that is both open and scalable. Each module plays a critical role in the overall functionality of the system:

Identity Administration

Identity administration includes creation and management of identities in Oracle Identity Manager. Identities include users, organizations, and roles. Identity administration also enables password management and user Oracle Identity Manager Self Service operations. Identity administration is performed by using Oracle Identity Manager Administration and Oracle Identity Manager Self Service Web clients, and the SPML Web service.

Provisioning

The provisioning transactions are assembled and modified in the provisioning module. This module maintains the "who" and "what" of provisioning. User profiles, access policies, and resources are defined in the provisioning module, as are business process workflows and business rules.

The Provisioning Server is the run-time engine for Oracle Identity Manager. It runs the provisioning process transactions as defined through Oracle Identity Manager Administration and Oracle Identity Manager Design Console and maintained within the provisioning module.

Audit and Reports

The audit and compliance functions include evaluating a person, organization, system, process, project, or product. This occurs by capturing data generated by the suite's workflow, policy, and reconciliation engines. By combining this data with identity data, an enterprise has all the information it requires to address any identity and to access a related audit inquiry. Audits are performed to ascertain the validity and reliability of information, and also provide an assessment of a system's internal control.

Reporting is the process of generating a formal document, which is created as a result of an audit. The report is subsequently provided to a user, such as an individual, a group of persons, a company, a government, or even the general public, as an assurance service so that the user can make decisions, based on the results of the audit. An enterprise can create reports on both the history and the current state of its provisioning environment. Some captured identity data includes user identity profile history, role membership history, user resource access, and fine-grained entitlement history.

Reconciliation and Bulk Load

The reconciliation engine ensures consistency between the provisioning environment of Oracle Identity Manager and Oracle Identity Manager managed resources within the organization. The reconciliation engine discovers illegal accounts created outside Oracle Identity Manager. The reconciliation engine also synchronizes business roles located inside and outside the provisioning system to ensure consistency.

If you want to load a large amount of data from other repositories in your organization into Oracle Identity Manager, then you can use the Bulk Load utility. The Bulk Load utility reduces the downtime in loading the data. In addition, Bulk Load utility import Oracle Identity Manager users, roles, role memberships, and accounts provisioned to users.

Common Services

Various services are grouped together that are shared and used by other Oracle Identity Manager components. These services are:

Form Designer

A form that allows you to create process and resource object forms that do not come packaged with Oracle Identity Manager.

Scheduler

A service that provides the capability to run specific jobs at specific schedules. This service can be used by users, application developers, connector developer, and administrators to create and configure a Job to be run at specified intervals. In addition, this service provides administrative capabilities to manage the functionality of jobs and their schedules.

Notification Templates

A common notification service is used by other functional components to send notifications to interested parties about events occurring in Oracle Identity Manager. In addition, this service provides the administrative capabilities for notification template management. A notification template is used for sending the outgoing notifications. These templates typically contain the variables that refer to the available data to provide more contextual content.

System Properties

A system property is an entity that controls the configuration aspect of an application. In addition, to the default system properties, you can create and manage system properties in Oracle Identity Manager.

Deployment Manager

The Deployment Manager is a tool for exporting and importing Oracle Identity Manager configurations. The Deployment Manager enables you to export the objects that make up your Oracle Identity Manager configuration.

Workflow and Request Management

Various operations in Oracle Identity Manager cannot be performed directly. Instead, the operations must be requested. The request management service provides a mechanism to create, approve, and manage requests. A request is an entity created by the users or administrators who want to perform a specific action, which requires a discretionary permission to be obtained from someone or some process before the action can be performed. For example, a user can create a request to gain access to a laptop computer, a manager can approve the request and create an open requisition, and an IT resource administrator can approve the request.

The primary goal of a provisioning solution is to manage requests and provision resources. Request service provides an abstraction layer on the Business Process Execution Language (BPEL) 11g workflow engine. Functional components such as request, provisioning, and attestation interacts with the workflow engine for human approvals. Request service caters to the various functional components in Oracle Identity Manager by managing workflow instances and categories, and provides an abstraction layer on BPEL.

Infrastructure and Middleware Integration

The Adapter Factory, Kernel Orchestration mechanism, Context Manager, and Plug-in Framework are designed to eliminate the need for hard-coding integrations with these systems.

Connector Framework

The integration solution strategy of Oracle Identity Manager provides connectors to various heterogeneous identity-aware IT systems. This strategy is designed to minimize custom development, maximize the reuse of code, and reduce deployment time. The tiers of the integration solution are:

- Out-of-the box integration using predefined connectors and predefined generic technology connector providers
 - Identity connectors that are designed to separate the implementation of an application from the dependencies of the system that the application is attempting to connect to
 - Connectors based on custom generic technology connector providers
 - Custom connectors using the Adapter Factory

Following figure illustrates the system components of Oracle Identity Manager.

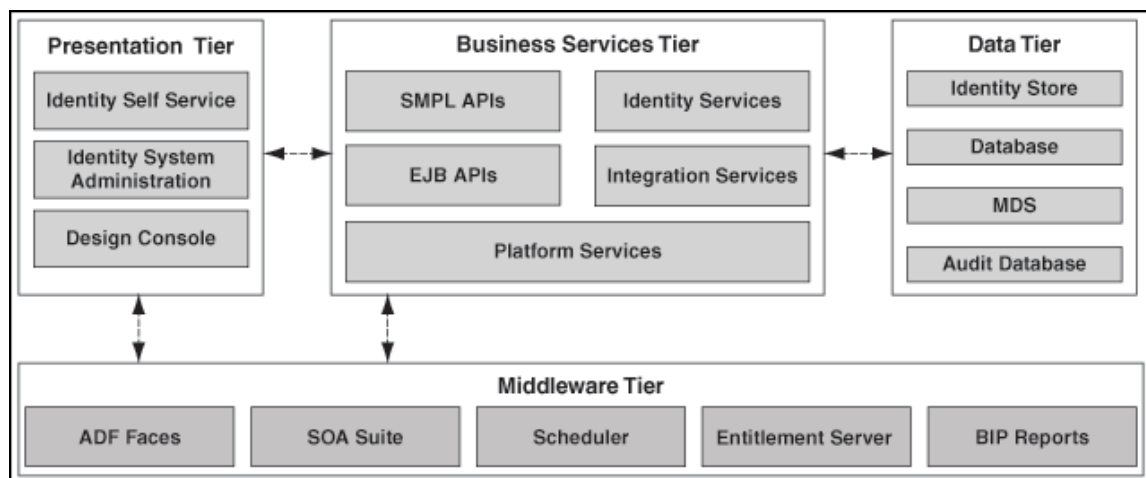

4.2 Integration / Design Architecture

With the integration of FCIS and Oracle Identity Manager, a user can be created, modified, closed, and reopened in FCIS. Oracle Identity Manager acts as the front-end entry point for managing mandatory fields of FCIS user. After users are provisioned, the users can access the FCIS without any interaction with Oracle Identity Manager. This integration also ensures that any change that has been made for corresponding user in FCIS should be reflected in OIM using reconciliation feature of OIM.

Design

For the purpose of integration of Oracle Identity manager and FCIS “Generic technology connector” (GTC) has been used. GTC provides out of box providers for provisioning and reconciliation.

Following two figures illustrate the design aspect of the provisioning and reconciliation process:

4.2.1 Provisioning Design Architecture

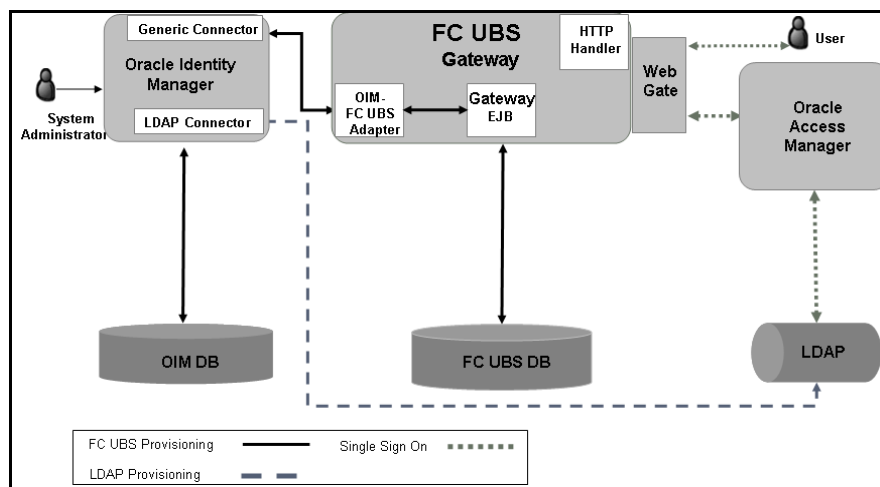

4.2.2 Reconciliation Design Architecture

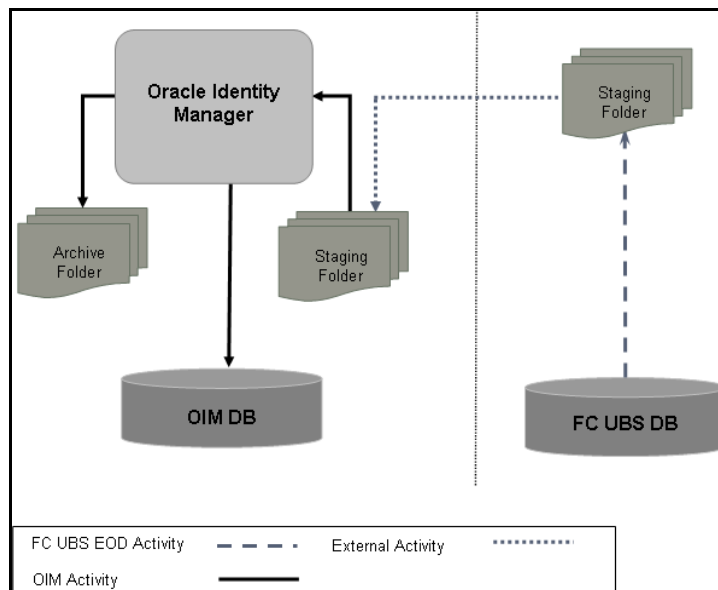

4.2.3 Design Constraints

The followings are the design constraints for this integration:

- This integration is based upon sample configuration containing only mandatory fields of FCIS user while defining the GTC. Other fields can be defined in the GTC using the same configurations.
- Due to specific data requirement for FCIS user creation, only manual provisioning method can be used for FCIS provisioning.
- User role is not taken up in this integration and the FCIS user will not be associated with any role at the time of user creation.
- A common FCIS maker id will be used for user creation that is maintained as property in a property file.
- OIM does not allow ASCII special characters e.g. ampersand, colon, braces etc. Apart from this, OIM also does not allow multiple consecutive occurrences of some of special ASCII character like underscore etc.

4.2.4 Message Flow

OIM-FCIS adapter would transform the request from the OIM SPML/DSML to FCIS Gateway request using Extensible Style sheet Language Transformation (XSLT). Transformed XML request will be sent to the FCIS Gateway EJB for further processing based on the type of the request. Based on the FCIS Gateway EJB response OIM-FCIS adapter will prepare the response in SPML/DSML format and will send to the OIM.

Following gives the sequence of the message exchanges between the adapter and FCIS Gateway EJB for user provisioning that are initiated from OIM.

4.2.4.1 Message exchange sequence for User Creation

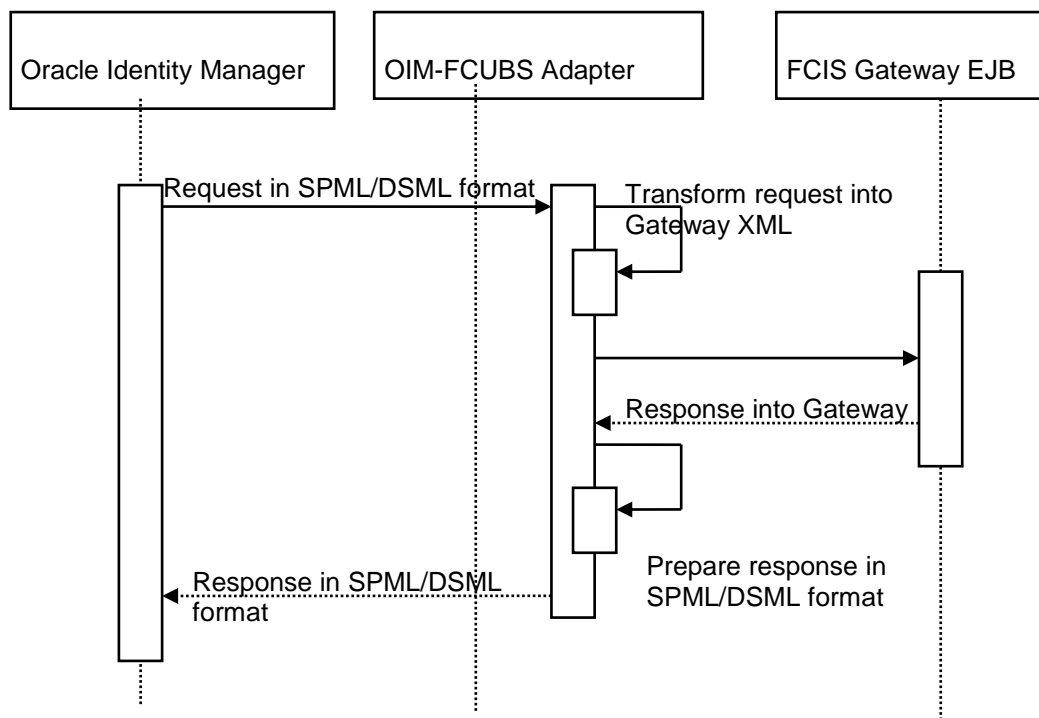

4.2.4.2 Message exchange sequence for User Field Modification/Set Password

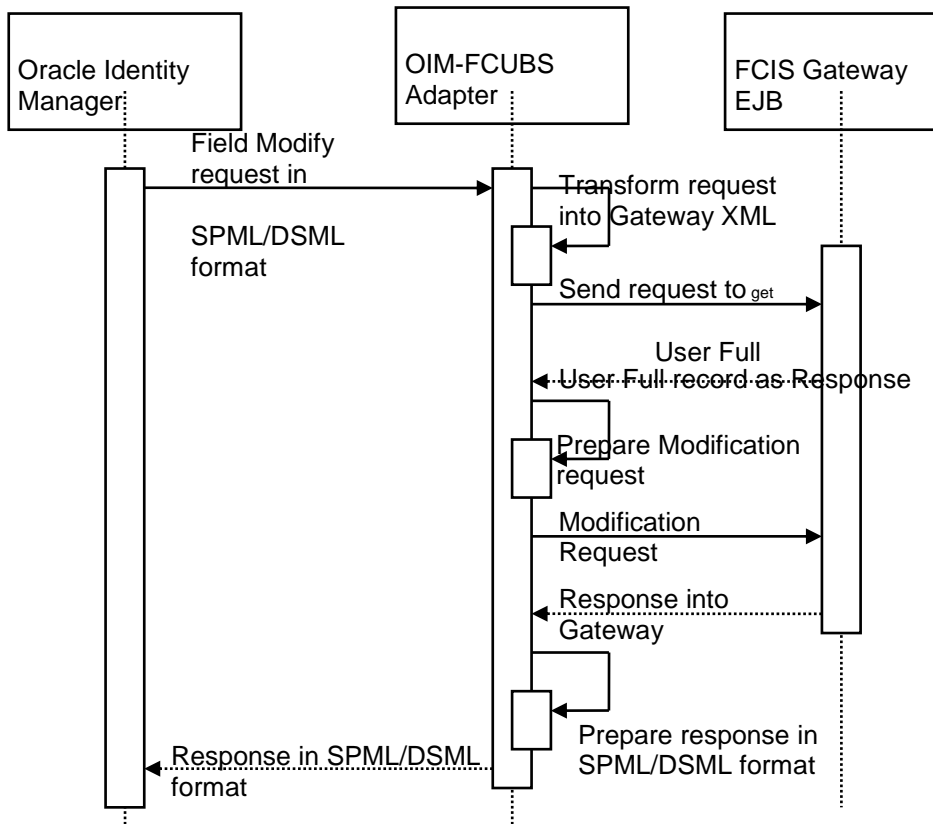

4.2.4.3 Message exchange sequence for User Delete/Suspend/Resume Request

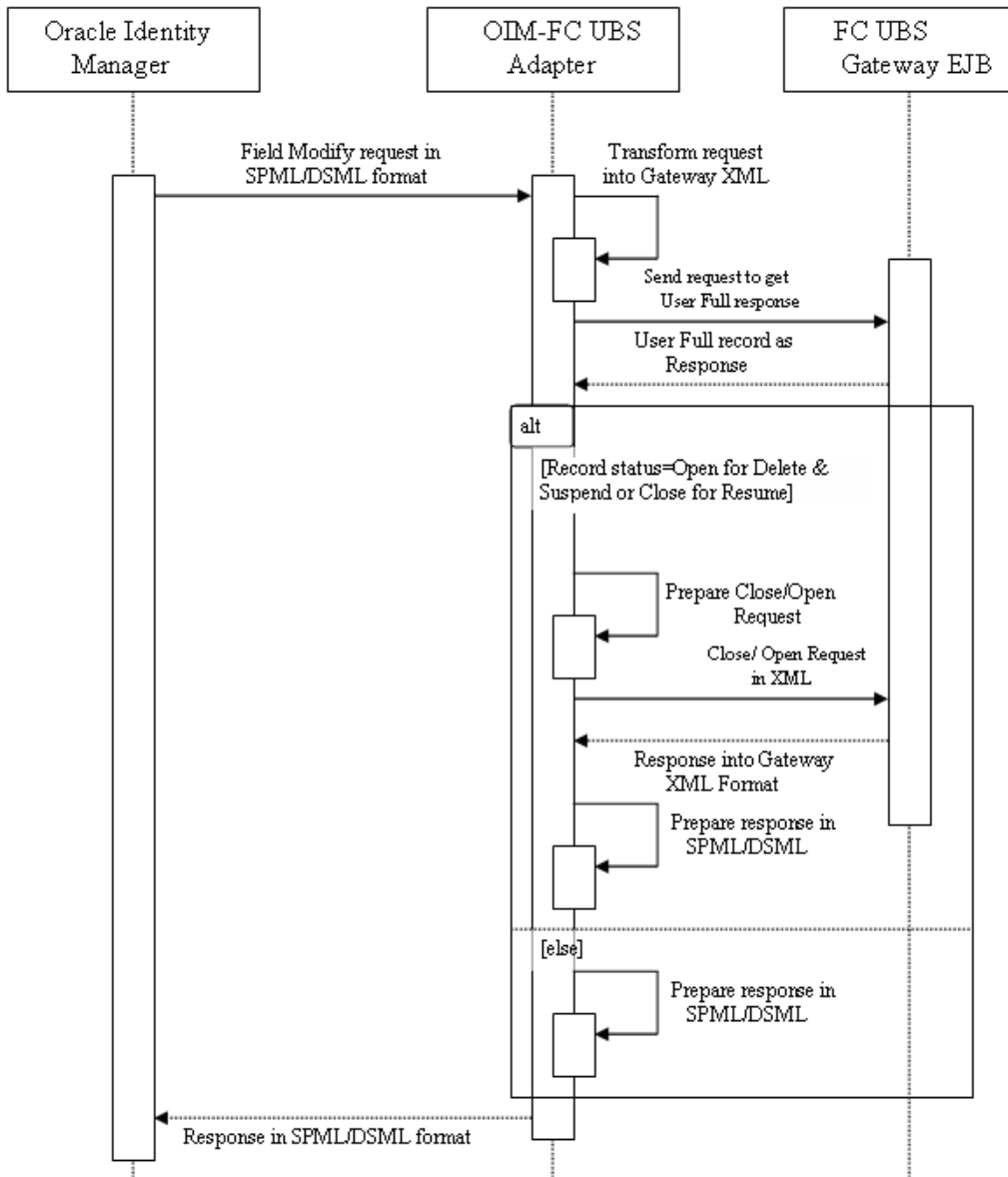

5. Installation / Configuration

5.1 Environment Setup/ Configurations

Oracle FLEXCUBE - OIM Integration environment setup requires

- OIM FLEXCUBE Adapter setup and configuration
- OIM setup

Note: This implementation document describes the installation and setup of OIM FLEXCUBE Adapter on Oracle Fusion Middleware 11g Release 2 (11.1.2.3.0).

5.1.1 Enabling SSL for Weblogic and OIM Server

5.1.1.1 Self-Signed Certificate Creation

To enable SSL mode, Weblogic requires a keystore which contains private and trusted certificates. We have to use the same version of JDK (which is used by Weblogic Domain), to create the keystore and certificates, otherwise it may lead to many difficulties (suggested by Oracle Support).

Keytool utility available in Java JDK will be used to create Keystore. In command prompt set PATH to the JDK\bin location. Follow the below steps to create keystore and self-signed certificates:Keystore Creation

5.1.1.1.1 Key Store Creation

```
keytool -genkey -keystore <keystore_name.jks> -alias <alias_name> -dname "CN=<hostname>,
OU=<Organization Unit>, O=<Organization>, L=<Location>, ST=<State>, C=<Country_Code>" -keyalg
<Key Algorithm> -sigalg <Signature Algorithm> -keysize <key size> -validity <Number of Days> -
keypass <Private key Password> -storepass <Store Password>
```

For example:

```
keytool -genkey -keystore AdminFlexcubeKeyStore.jks -alias FlexcubeCert -dname
"CN=ofss00001.in.oracle.com, OU=OFSS, O=OFSS, L=Chennai, ST=TN, C=IN" -keyalg "RSA" -sigalg
"SHA256withRSA" -keysize 2048 -validity 3650 -keypass Password@123 -storepass Password@123
```

Note: **CN=ofss00001.in.oracle.com** is the Host Name of the weblogic server

5.1.1.1.2 Export Private key as Certificate

```
keytool -export -v -alias <alias_name> -file <export_certificate_file_name_with_location.cer> -keystore
<keystore_name.jks> > -keypass <Private key Password> -storepass <Store Password>
```

For example:

```
keytool -export -v -alias FlexcubeCert -file AdminFlexcubeCert.cer -keystore AdminFlexcubeKeyStore.jks
-keypass Password@123 -storepass Password@123
```

5.1.1.1.3 Import as Trusted Certificate

```
keytool -import -v -trustcacerts -alias rootcert -file <export_certificate_file_name_with_location.cer> -  
keystore <keystore_name.jks> > -keypass <Private key Password> -storepass <Store Password>
```

For example:

```
keytool -import -v -trustcacerts -alias rootcert -file AdminFlexcubeCert.cer -keystore  
AdminFlexcubeKeyStore.jks -keypass Password@123 -storepass Password@123
```

References: Oracle Support Articles (Article ID 1281035.1, Article ID 1218695.1), in case of Certificates issued by the Trusted Authorities

5.1.1.2 Configuring Weblogic Console

After domain creation, follow the below steps to enable SSL in Weblogic Admin server, OIM Server and SOA Server.

5.1.1.2.1 Select Admin Server to enable SSL options

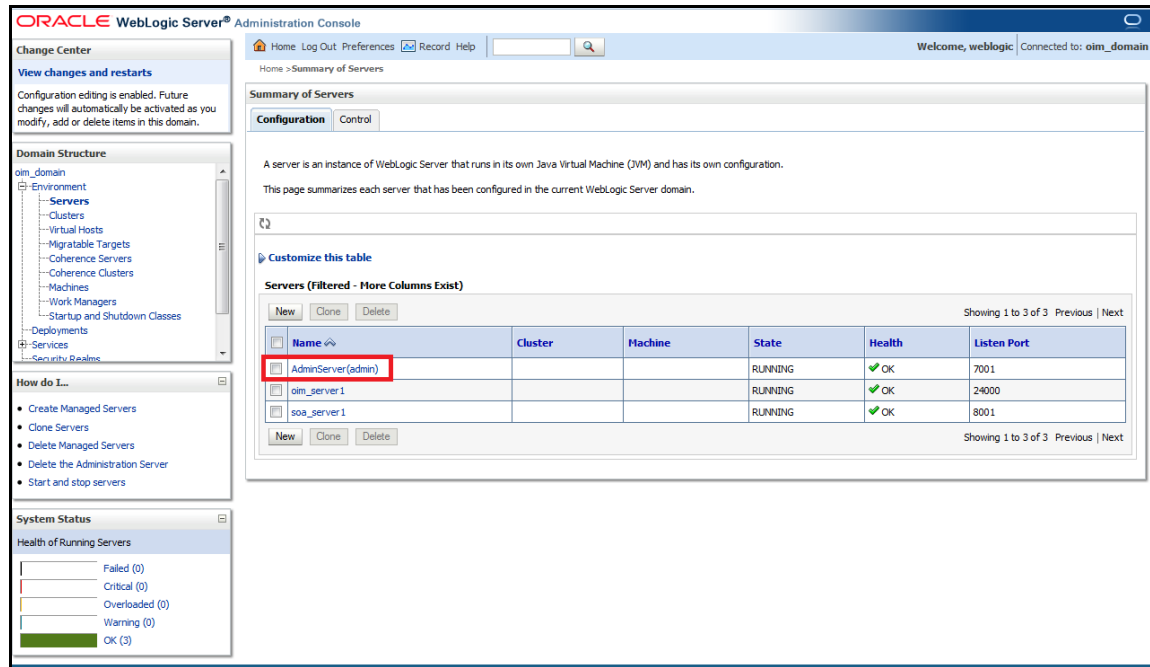

The screenshot shows the Oracle WebLogic Server Administration Console interface. The main content area displays the 'Summary of Servers' page, which includes a table of servers. The 'AdminServer(admin)' server is highlighted with a red box. The table has columns for Name, Cluster, Machine, State, Health, and Listen Port. The 'AdminServer(admin)' server is in a 'RUNNING' state with a 'Health' of 'OK' and a 'Listen Port' of 7001. Other servers listed are 'oim_server1' and 'soa_server1', both also in 'RUNNING' state with 'OK' health and listen ports of 24000 and 8001 respectively.

| Name | Cluster | Machine | State | Health | Listen Port |
|--------------------|---------|---------|---------|--------|-------------|
| AdminServer(admin) | | | RUNNING | OK | 7001 |
| oim_server1 | | | RUNNING | OK | 24000 |
| soa_server1 | | | RUNNING | OK | 8001 |

5.1.1.2.2 Follow the steps in General Tab as shown below:

1. Select SSL Listen Port Enabled, Client Cert Proxy Enabled, Weblogic Plug-In Enabled.
2. Click on Save.

The screenshot shows the 'General' tab of the Oracle WebLogic Server Administration Console for the 'AdminServer'. The 'Save' button is highlighted in red. The 'SSL Listen Port Enabled', 'Client Cert Proxy Enabled', and 'Weblogic Plug-In Enabled' checkboxes are also highlighted in red. The 'Listen Address' field is empty, 'Listen Port' is 7001, and 'SSL Listen Port' is 7002. The 'Virtual Machine Name' is iam_domain_AdminSe.

5.1.1.2.3 Follow the steps in Keystores Tab as shown below:

1. Click Change and select Keystores as **Custom Identity and Custom Trust**
2. Click on Save
3. Note: Keystores as **Custom Identity and Custom Trust** is as suggested by Oracle Support Team

The screenshot shows the 'Keystores' tab of the Oracle WebLogic Server Administration Console for the 'AdminServer'. The 'Save' button is highlighted in red. The 'Keystores' dropdown menu is open, showing 'Custom Identity and Custom Trust' selected and highlighted in red.

5.1.1.2.4 Follow the steps in Keystores Tab as shown below:

4. Enter Custom Identity Keystore and Custom Trust Keystore as same as the Keystore Name created in step 5.1.1.1.1 with full path.
5. Enter Custom Identity Keystore Type and Custom Trust Keystore Type as jks.
6. Enter Custom Identity Keystore Passphrase, Confirm Custom Identity Keystore Passphrase, Custom Trust Keystore Passphrase and Confirm Custom Trust Keystore Passphrase as same as the Store Password entered in step 5.1.1.1.1.
7. Click on Save.

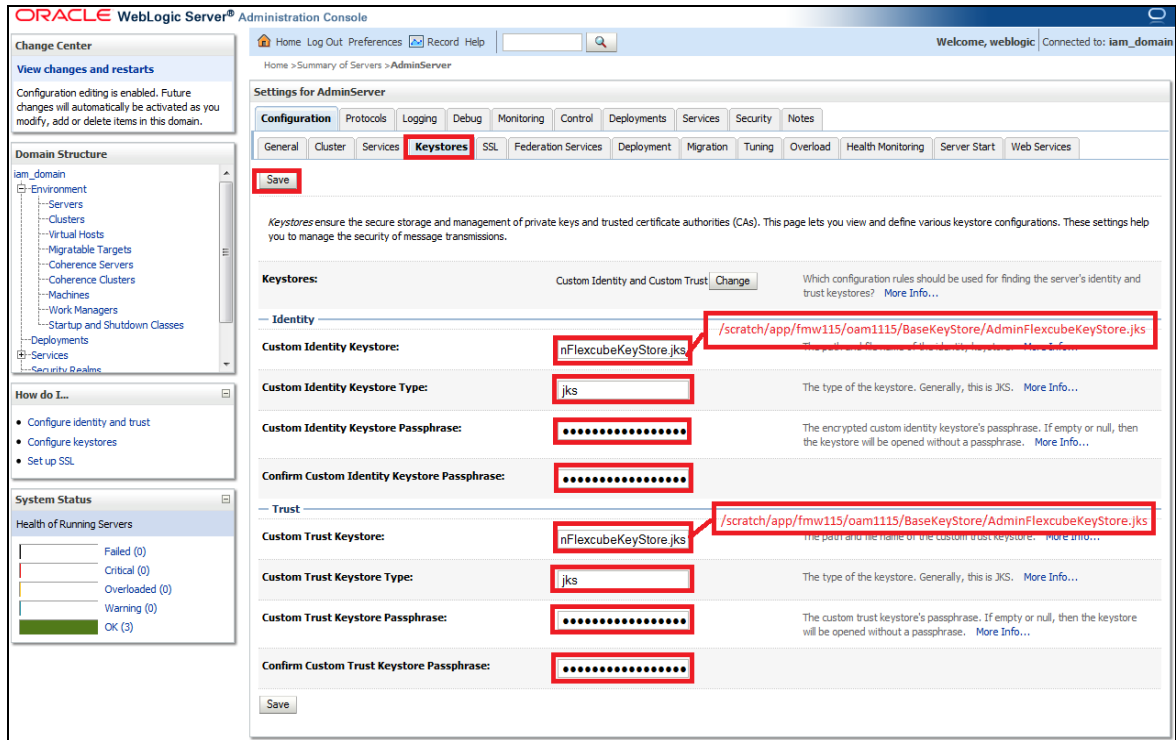

5.1.1.2.5 Follow the steps in SSL Tab as shown below:

1. Enter Private Key Alias as same as the alias name entered in step [5.1.1.1.1](#).
2. Enter Private Key Passphrase and Confirm Private Key Passphrase as same as the Private Key Password entered in step [5.1.1.1.1](#).
3. Change the Hostname Verification to None.
4. Use JSSE SSL option should be remain unchecked
5. Click on Save.

The screenshot displays the Oracle WebLogic Administration Console interface. The main content area is titled 'Settings for AdminServer' and is currently on the 'SSL' tab. A red box highlights the 'Save' button at the top left of the configuration area. Below the 'Save' button, there is a descriptive paragraph: 'This page lets you view and define various Secure Sockets Layer (SSL) settings for this server instance. These settings help you to manage the security of message transmissions.'

The configuration is organized into sections:

- Identity and Trust Locations:** Includes a 'Change' button and a description: 'Indicates where SSL should find the server's identity (certificate and private key) as well as the server's trust (trusted CAs). More Info...'
- Identity:**
 - Private Key Location:** Set to 'from Custom Identity Keystore'. Description: 'The keystore attribute that defines the location of the private key file. More Info...'
 - Private Key Alias:** Set to 'FlexcubeCert' (highlighted with a red box). Description: 'The keystore attribute that defines the string alias used to store and retrieve the server's private key. More Info...'
 - Private Key Passphrase:** Set to '.....' (highlighted with a red box). Description: 'The keystore attribute that defines the passphrase used to retrieve the server's private key. More Info...'
 - Confirm Private Key Passphrase:** Set to '.....' (highlighted with a red box). Description: 'The keystore attribute that defines the passphrase used to retrieve the server's private key. More Info...'
 - Certificate Location:** Set to 'from Custom Identity Keystore'. Description: 'The keystore attribute that defines the location of the trusted certificate. More Info...'
- Trust:**
 - Trusted Certificate Authorities:** Set to 'from Custom Trust Keystore'. Description: 'The keystore attribute that defines the location of the certificate authorities. More Info...'
- Advanced:**
 - Hostname Verification:** Set to 'None' (highlighted with a red box). Description: 'Specifies whether to ignore the installed implementation of the weblogic.security.SSL.HostnameVerifier interface (when this server is acting as a client to another application server). More Info...'
 - Custom Hostname Verifier:** Set to 'None' (highlighted with a red box). Description: 'The name of the class that implements the weblogic.security.SSL.HostnameVerifier interface. More Info...'
- Export Key Lifespan:** Set to '500'. Description: 'Indicates the number of times WebLogic Server can use an exportable key between a domestic server and an exportable client before generating a new key. The more secure you want WebLogic Server to be, the fewer times the key should be used before generating a new key. More Info...'

At the bottom of the page, there is a checkbox labeled 'Use Server Certs' with the description: 'Sets whether the client should use the server certificates/key as the client.'

The left sidebar contains the 'Change Center' with a 'View changes and restarts' section, a 'Domain Structure' tree showing the 'iam_domain' hierarchy, and a 'System Status' section showing 'Health of Running Servers' with 'OK (2)' servers.

5.1.1.2.6 Select OIM Server and SOA Server to enable SSL options and Repeat the steps performed in 5.1.1.2.2 to 5.1.1.2.5

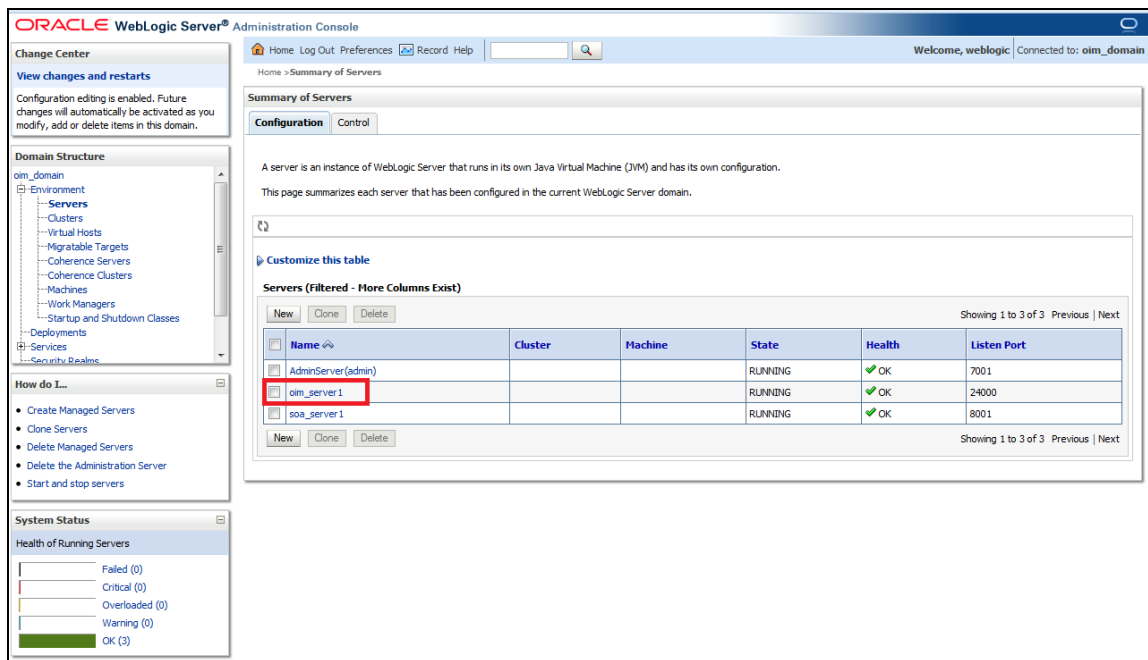

5.1.1.2.7 Now the admin_server, oim_server and soa_server are SSL enabled. Restart all three servers.

5.1.2 Enabling SSL on GTC Connector Server

To have SSL enabled Provisioning Web Service in [5.1.5.23](#). We have to have a two way handshake between GTC Connector Server and the Application Server, where FCUBSProvisioningAdService web service deployed.

5.1.2.1 Export the KeyStore Certificate in [5.1.1.1.1](#)

```
keytool -export -alias <aliasname> -file <exportfilename> -keystore <keystorename> -storetype jks -storepass <keystorepassword> -provider sun.security.provider.Sun
```

For Example:

```
keytool -export -alias FlexcubeCert -file webfile.cer -keystore FlexcubeKeyStore.jks -storetype jks -storepass Password@123 -provider sun.security.provider.Sun
```

5.1.2.2 Import the Certificate to Xellarate Key Store

```
keytool -import -trustcacerts -alias <aliasname> -noprompt -keystore <Domain_home>/config/fmwconfig/default-keystore.jks -file <importfilename> -storepass <keystorepassword>
```

For Example:

```
keytool -import -trustcacerts -alias FlexcubeCert -noprompt -keystore /app/Middleware/user_projects/domains/oim_domain/config/fmwconfig/default-keystore.jks -file webfile.cer -storepass Password123
```

Note *: <Domain_home>/config/fmwconfig/default-keystore.jks will be the KeyStore Password while configuring OIM Server. To have this feature, you should have only Weblogic Admin Server, OIM Server and SOA Server in this OIM Domain.

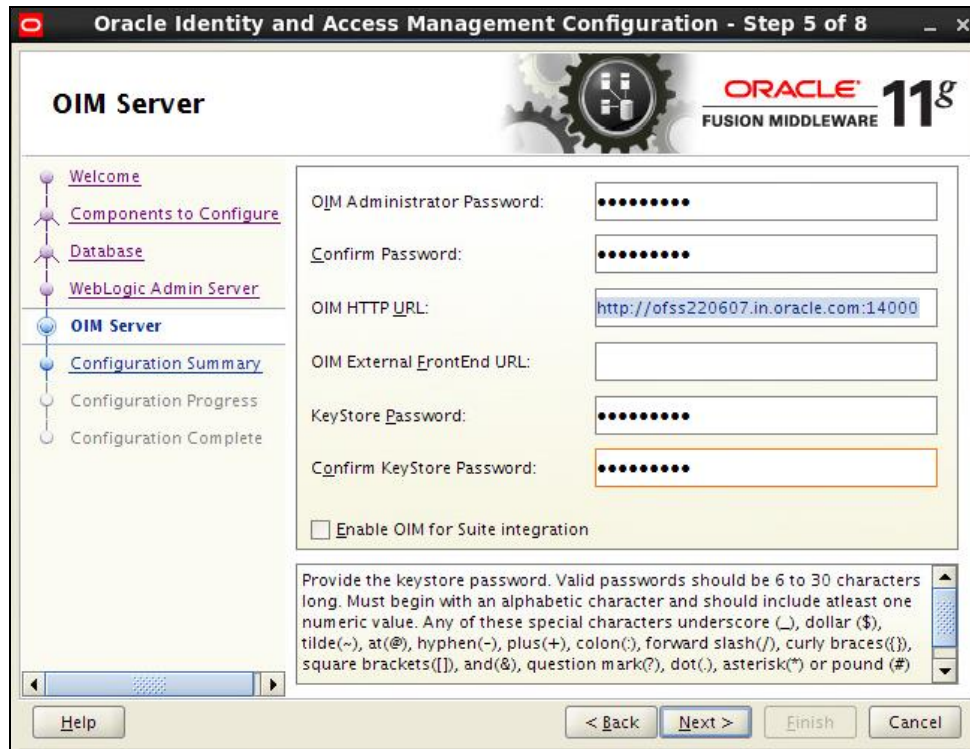

5.1.2.3 Export Xellarate KeyStore Certificate

```
keytool -export -alias xell -noprompt -keystore <Domain_home>/config/fmwconfig/default-keystore.jks -file <xellexportfilename> -storetype jks -provider sun.security.provider.Sun
```

For Example:

```
keytool -export -alias xell -noprompt -keystore /app/Middleware/user_projects/domains/oim_domain/config/fmwconfig/default-keystore.jks -file xellcertificate.cer -storetype jks -provider sun.security.provider.Sun
```

5.1.2.4 Import the Xellarate Certificate to KeyStore Created in [5.1.1.1](#)

```
keytool -import -alias <aliasname> -trustcacerts -file <xellimportfilename> -keystore <keystorename> -storetype jks -storepass <keystorepassword> -provider sun.security.provider.Sun
```

For Example:

```
keytool -import -alias xellcertificate -trustcacerts -file xellcertificate.cer -keystore FlexcubeKeyStore.jks -storetype jks -storepass Password@123 -provider sun.security.provider.Sun
```

5.1.3 Configuring SSL Mode in Oracle Internet Directory

To enable SSL for OID LDAP Server refer and follow the below steps:

5.1.3.1 Login to the Enterprise Manager Console of the domain, in which Oracle Internet Directory is associated

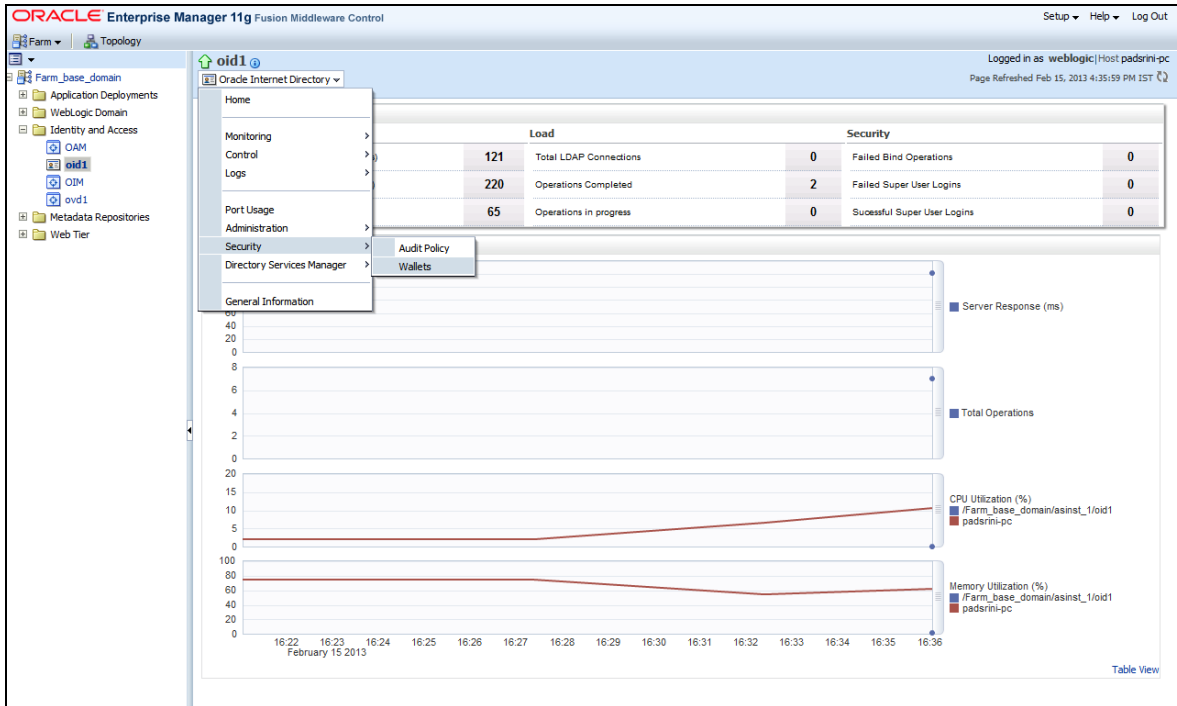

5.1.3.2 Click on Create Self-Signed Wallet

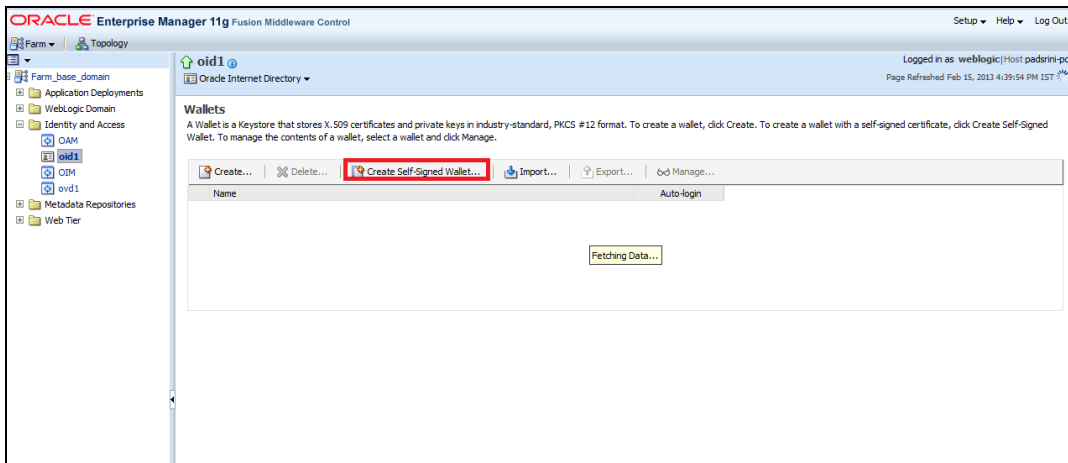

5.1.3.3 Enter the Details as below and Click on OK

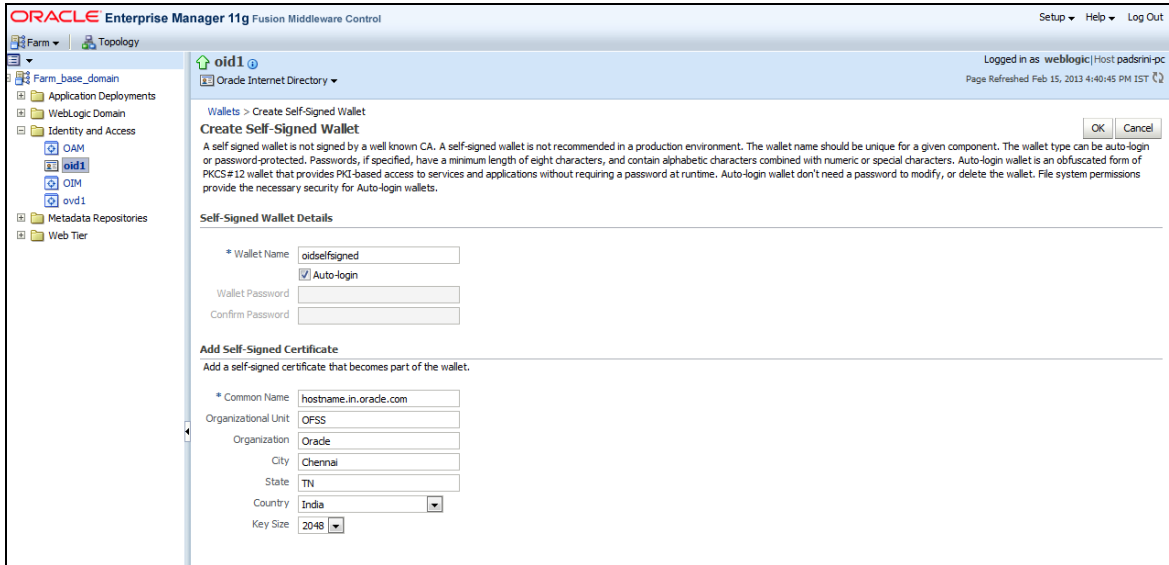

ORACLE Enterprise Manager 11g Fusion Middleware Control

Setup Help Log Out

Logged in as weblogic@Host padsrini-pc
Page Refreshed Feb 15, 2013 4:40:45 PM IST

Walleys > Create Self-Signed Wallet

Create Self-Signed Wallet

A self signed wallet is not signed by a well known CA. A self-signed wallet is not recommended in a production environment. The wallet name should be unique for a given component. The wallet type can be auto-login or password-protected. Passwords, if specified, have a minimum length of eight characters, and contain alphabetic characters combined with numeric or special characters. Auto-login wallet is an obfuscated form of PKCS#12 wallet that provides PKI-based access to services and applications without requiring a password at runtime. Auto-login wallet don't need a password to modify, or delete the wallet. File system permissions provide the necessary security for Auto-login wallets.

Self-Signed Wallet Details

* Wallet Name:

Auto-login

Wallet Password:

Confirm Password:

Add Self-Signed Certificate

Add a self-signed certificate that becomes part of the wallet.

* Common Name:

Organizational Unit:

Organization:

City:

State:

Country:

Key Size:

5.1.3.4 Click on Manage...

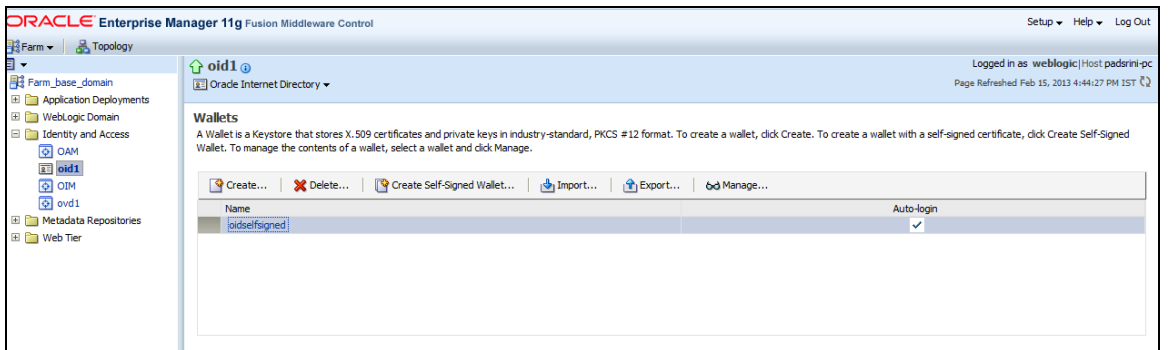

ORACLE Enterprise Manager 11g Fusion Middleware Control

Setup Help Log Out

Logged in as weblogic@Host padsrini-pc
Page Refreshed Feb 15, 2013 4:44:27 PM IST

Walleys

A Wallet is a Keystore that stores X.509 certificates and private keys in industry-standard, PKCS #12 format. To create a wallet, click Create. To create a wallet with a self-signed certificate, click Create Self-Signed Wallet. To manage the contents of a wallet, select a wallet and click Manage.

Create... Delete... Create Self-Signed Wallet... Import... Export... **Manage...**

| Name | Auto-login |
|---------------|-------------------------------------|
| oidselfsigned | <input checked="" type="checkbox"/> |

5.1.3.5 Select the Trusted Certificate and Click on Export

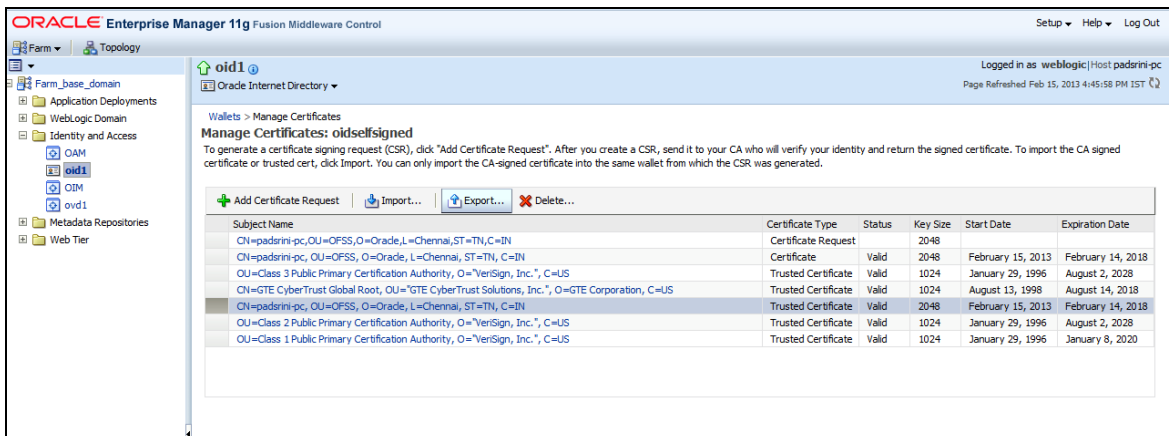

ORACLE Enterprise Manager 11g Fusion Middleware Control

Setup Help Log Out

Logged in as weblogic@Host padsrini-pc
Page Refreshed Feb 15, 2013 4:45:58 PM IST

Walleys > Manage Certificates

Manage Certificates: oidselfsigned

To generate a certificate signing request (CSR), click "Add Certificate Request". After you create a CSR, send it to your CA who will verify your identity and return the signed certificate. To import the CA signed certificate or trusted cert, click Import. You can only import the CA-signed certificate into the same wallet from which the CSR was generated.

Add Certificate Request Import... **Export...** Delete...

| Subject Name | Certificate Type | Status | Key Size | Start Date | Expiration Date |
|---|----------------------------|--------------|-------------|--------------------------|--------------------------|
| CN=padsrini-pc, OU=OFSS, O=Oracle, L=Chennai, ST=TN, C=IN | Certificate Request | | 2048 | | |
| CN=padsrini-pc, OU=OFSS, O=Oracle, L=Chennai, ST=TN, C=IN | Certificate | Valid | 2048 | February 15, 2013 | February 14, 2018 |
| OU=Class 3 Public Primary Certification Authority, O="VeriSign, Inc.", C=US | Trusted Certificate | Valid | 1024 | January 29, 1996 | August 2, 2028 |
| CN=GTE CyberTrust Global Root, OU="GTE CyberTrust Solutions, Inc.", O=GTE Corporation, C=US | Trusted Certificate | Valid | 1024 | August 13, 1998 | August 14, 2018 |
| CN=padsrini-pc, OU=OFSS, O=Oracle, L=Chennai, ST=TN, C=IN | Trusted Certificate | Valid | 2048 | February 15, 2013 | February 14, 2018 |
| OU=Class 2 Public Primary Certification Authority, O="VeriSign, Inc.", C=US | Trusted Certificate | Valid | 1024 | January 29, 1996 | August 2, 2028 |
| OU=Class 1 Public Primary Certification Authority, O="VeriSign, Inc.", C=US | Trusted Certificate | Valid | 1024 | January 29, 1996 | January 8, 2020 |

5.1.3.6 Click Export Trusted Certificate and save the certificate file

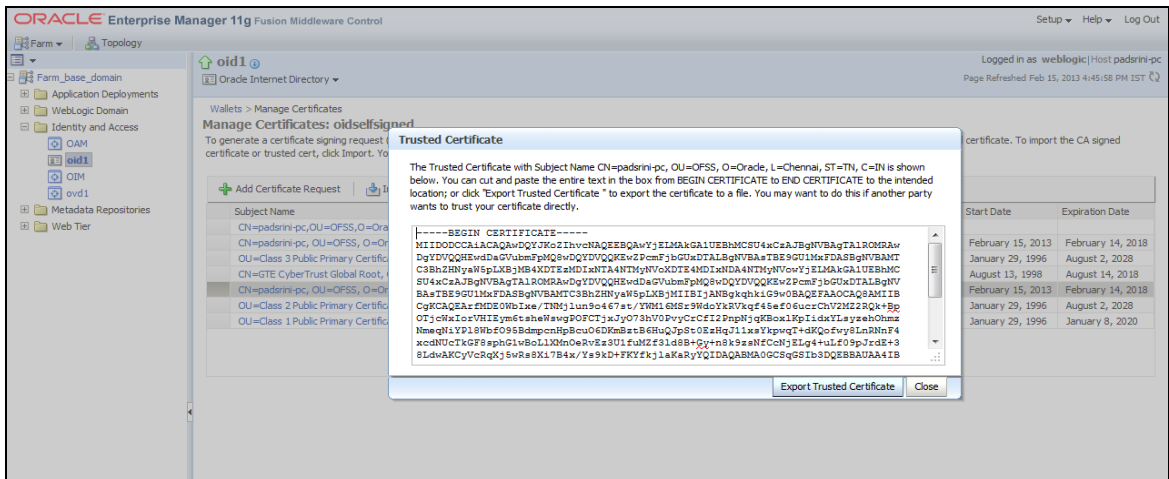

5.1.3.7 Click on Server Properties

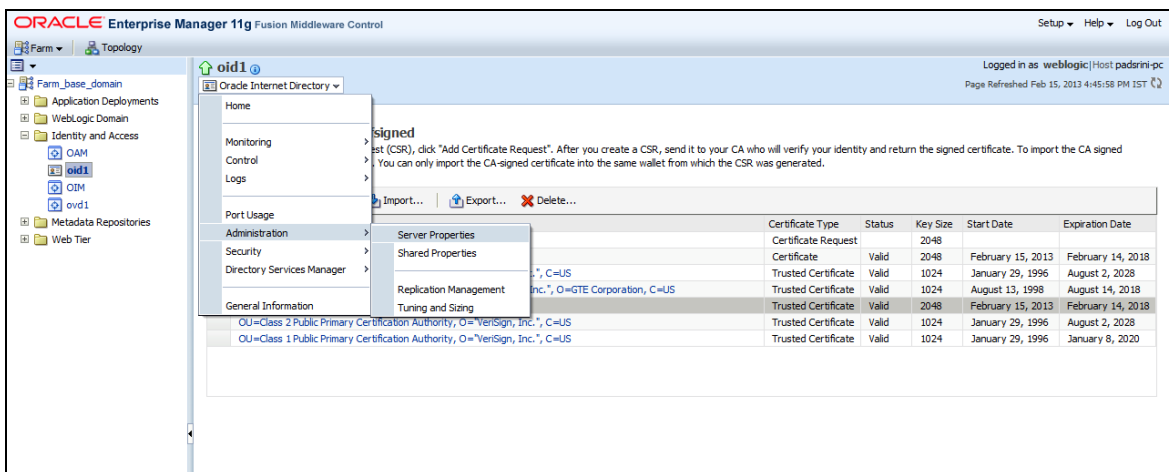

5.1.3.8 Click on Change SSL Settings

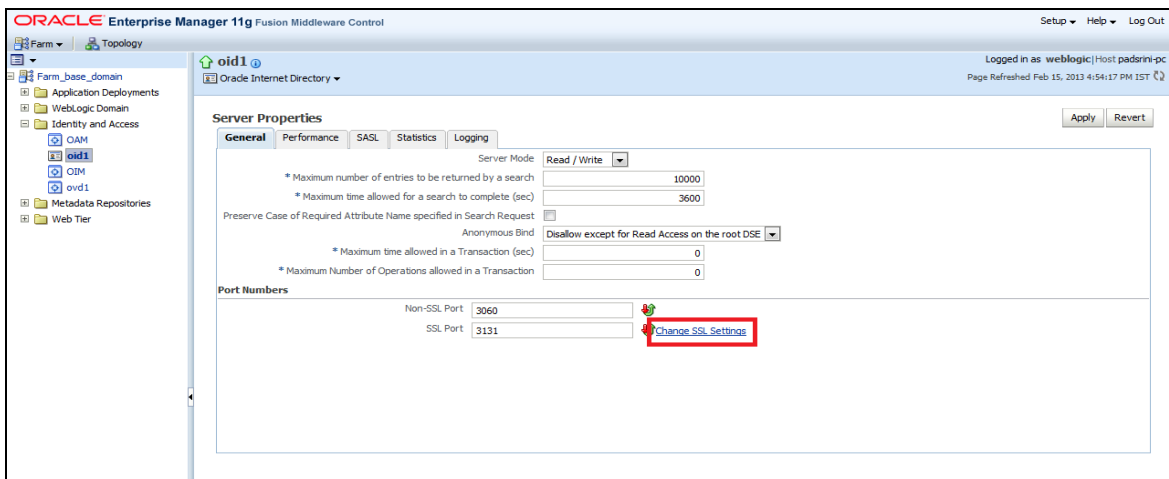

5.1.3.9 Select the Wallet, SSL Authentication as Server Authentication, Cipher Suite, SSL Protocol Version as below and Click on OK

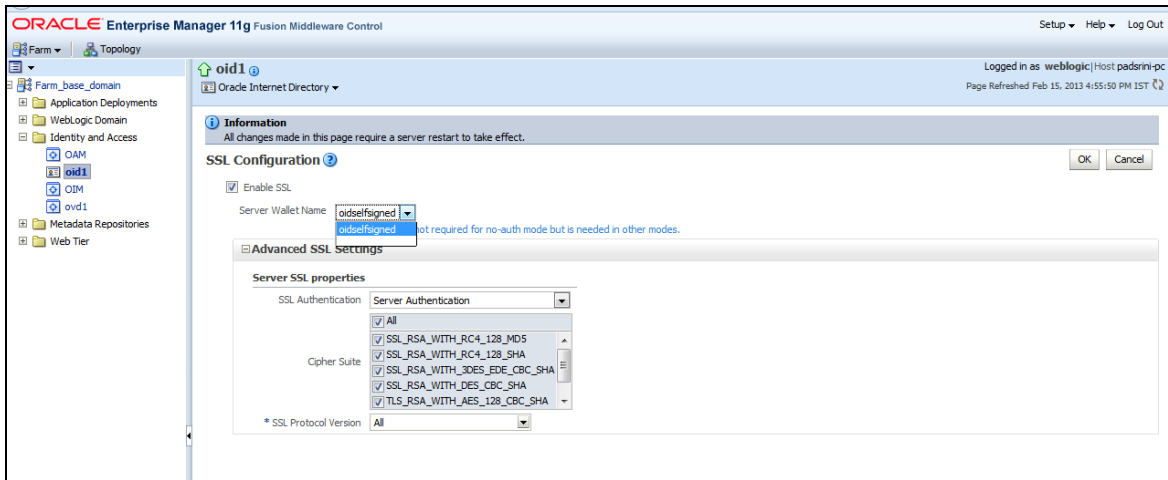

5.1.3.10 Click on Apply

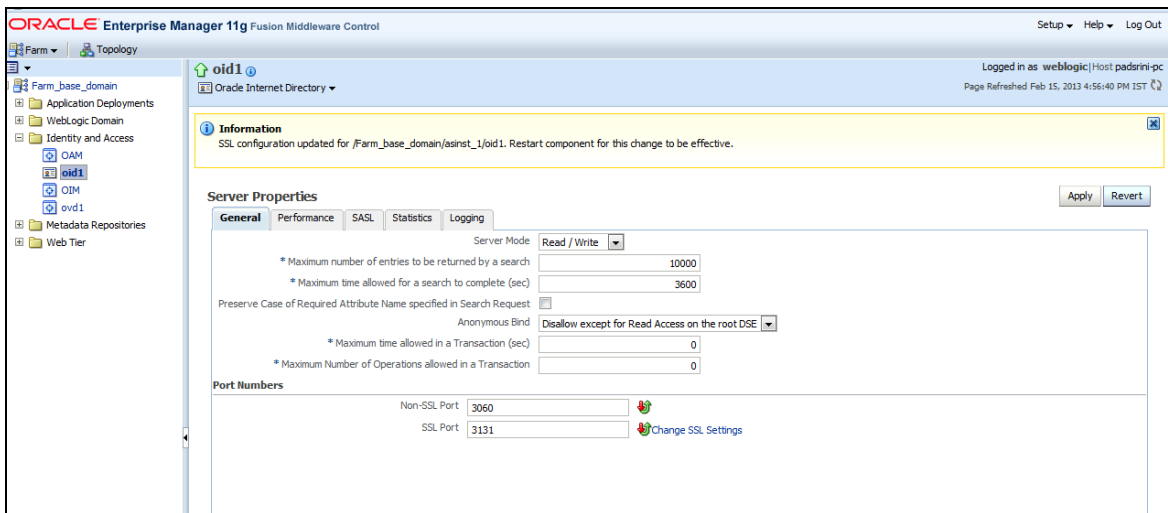

5.1.3.11 Import LDAP Server SSL Certificate into OIM Server

Import the Exported Certificate into **wlserver_10.3/server/lib/DemoTrust.jks** of OIM Server Domain using the below command [Store Password is **DemoTrustKeyStorePassPhrase**]

```
keytool -import -keystore MW_HOME/wlserver_10.3/server/lib/DemoTrust.jks -file /home/testoc4j/OIM/globalv.crt -storepass DemoTrustKeyStorePassPhrase
```

Restart Both OID & OIM Server.

5.1.4 **OIM FLEXCUBE Adapter Setup**

Prerequisite: Gateway EJB component

OIM FCIS adapter consists of two web services:

- FCUBSLOVAdService : To fetch list of values from FCIS Database
- FCUBSProvisioningAdService: To handle OIM's request and response for user provisioning and de-provisioning services. This web service requires FCIS Gateway EJB either on same Weblogic Application server or another. If it is on same Weblogic Application server then this web service is deployed as child of Gateway EJB.

OIM FCIS adapter setup is all about deployment of these web services on Oracle Fusion Middleware 11g Release 2 (11.1.2.3.0).

5.1.4.1 **Environment Setup**

The following steps to be followed to do the initial environment setup for OIM FCIS adapter deployment:

5.1.4.1.1 **Copy following folders from the FCIS Software Release area**

- <FCIS Release Name>\ADAPTERS\OIM\FCUBSLOVAdService
- <FCIS Release Name>\ADAPTERS\OIM\FCUBSProvisioningAdService
- <FCIS Release Name>\ADAPTERS\OIM\setup

to local machine (say **D:\OIM** for WINDOWS or **/home/kernel/OIM** for UNIX).

Note: If Gateway EJB server and OIM server is on same system, then copy entire folder from FCIS software release area to local machine.

In this document SPMLADAPTER_INSTALL_DIR specifies the directory where adapter will be installed.

e.g.

For WINDOWS:

SPMLADAPTER_INSTALL_DIR=D:\

For UNIX:

SPMLADAPTER_INSTALL_DIR=/home/kernel/

OIM_SERVER_INSTALL_DIR specifies the OIM server installation directory (like D:\Oracle\Middleware\weblogic\Oracle_IDM1 in windows or /Oracle/Middleware/weblogic/ Oracle_IDM1 in unix).

5.1.4.1.2 **Create a Data source in WebLogic Server Version: 10.3.6.0.**

[\[Refer Appendix 8.1 Data Source Creation\]](#)

5.1.4.1.3 Modify configuration files as below:

Edit **<SPMLADAPTER_INSTALL_DIR>\OIM\FCUBSLOVAdService\src\webcontent\WEB-INF\web.xml**. This XML file shall have a similar section as the one shown below (Change the values given in bold)

```
<resource-ref>
    <res-ref-name>OIMLOVSQA</res-ref-name>
    <res-type>javax.sql.DataSource</res-type>
    <res-auth>Container</res-auth>
</resource-ref>
<env-entry>
    <description>Property File Path</description>
    <env-entry-name>propertyPath</env-entry-name>
    <env-entry-type>java.lang.String</env-entry-type>
    <env-entry-value>D:/OIM/FCUBSLOVAdService/config</env-entry-value>
</env-entry>
```

Edit resource-ref section: Mention the JNDI name of the Datasource created in Application server for FLEXCUBE UBS Messaging Database Layer Instance at step 3 as res-ref-name.

Edit Property File Path: Give the absolute path for lookup_prop.xml as env-entry-value. Ideally, this file is residing in **< SPMLADAPTER_INSTALL_DIR>\OIM\FCUBSLOVAdService\config**.

Note: Give "/" for at the end of the path. Also, note that as separator forward slash has been used instead of backward.

Edit **<SPMLADAPTER_INSTALL_DIR>\OIM\FCUBSLOVAdService\config\lookup_prop.xml**. This XML file shall have a similar section as the one shown below, (Change the values given in bold)

```
<!-- DataBase Connection -->
    <add key="FCUBS_CON_POOLNAME" value="OIMLOVSQA" />
<!-- DataBase Connection -->
<add key="LOGGER_PATH"
value="D:/OIM/FCUBSLOVAdService/config/lookup_logger.xml" />
```

Edit FCUBS_CON_POOLNAME: Give the same Datasource JNDI name mentioned in above web.xml for FLEXCUBE UBS Messaging Database Layer Instance.

Edit LOGGER_PATH: Give the logging configuration absolute path for lookup_logger.xml. This file is residing in **<SPMLADAPTER_INSTALL_DIR>\OIM\FCUBSLOVAdService\config** folder.

Note: As separator use forward slash instead of backward slash.

Edit **<SPMLADAPTER_INSTALL_DIR>\OIM\FCUBSLOVAdService\config\lookup_logger.xml**. This XML file shall have a similar section as the one shown below, (Change the values given in bold)

```
<add key="ADOIM.LOGGER.FPATH" value="D:/OIM/FCUBSLOVAdService/log/" />
```

ADOIM.LOGGER.FPATH: Give the absolute path where log files will be stored. It is recommended that mention the following path **<SPMLADAPTER_INSTALL_DIR>\OIM\FCUBSLOVAdService\log**

Note: As separator use forward slash instead of backward slash. Give "/" for at the end of the path.

Edit **<SPMLADAPTER_INSTALL_DIR>\OIM\FCUBSProvisioningAdService\src\webcontent\WEB-INF\web.xml**. This XML file shall have a similar section as the one shown below (Change the values given in bold)

```
<ejb-ref>
    <ejb-ref-name>GWEJB_GW_EJB_Bean</ejb-ref-name>
    <ejb-ref-type>Session</ejb-ref-type>
    <home>com.ofss.fcubs.gw.ejb.GWEJBRemoteHome</home>
    <remote>com.ofss.fcubs.gw.ejb.GWEJBRemote</remote>
</ejb-ref>
<env-entry>
    <description>Property File Path</description>
    <env-entry-name>propertyPath</env-entry-name>
    <env-entry-type>java.lang.String</env-entry-type>
    <env-entry-value>D:/OIM/FCUBSProvisioningAdService/config/</env-
entry-value>
</env-entry>
```

Edit ejb-link: To refer Gateway EJB from the web service locally the reference of Gateway EJB has been defined in this deployment descriptor file. Give the Gateway EJB name here as ejb-link, mentioned as ejb-name in ejb-jar.xml deployment descriptor file of Gateway EJB.

Edit Property File Path: Give the absolute path for ADOIM_Prop.xml as env-entry-value. This file is residing in **<SPMLADAPTER_INSTALL_DIR>\OIM\FCUBSProvisioningAdService\config**.

Note: Give "/" for at the end of the path. Also, note that as separator forward slash has been used instead of backward.

Edit <SPMLADAPTER_INSTALL_DIR>\OIM\FCUBSLOVAdService\config\ADOIM_Prop.xml. This XML file shall have a similar section as the one shown below, (Change the values given in bold)

```
<add key="GW_EJB_JNDI_NAME" value="
GWEJB#com.ofss.fcubs.gw.ejb.GWEJBRemote "/>

  <add key="GW_EJB_CALL_TYPE" value="REMOTE"/>

  <add key="GW_EJB_CTX_FACTORY"
value="weblogic.jndi.WLInitialContextFactory"/>

  <add key="GW_EJB_SERVER_URL" value="t3s://localhost:7102"/>

  <add key="GW_EJB_SECURITY_PRINCIPAL" value=""/>

  <add key="GW_EJB_SECURITY_CREDENTIALS" value=""/>
```

Edit GW_EJB_JNDI_NAME: Give the Gateway EJB JNDI name.

Edit GW_EJB_CALL_TYPE: Give the LOCAL or REMOTE (must be in Upper Case) based on the way EJB is to be referred from web service. If FCIS Gateway EJB is deployed on same Weblogic Application server then it should be REMOTE.

Edit GW_EJB_SERVER_URL: Give the application server URL where Gateway EJB is deployed.

Following are the parts that make this URL:

t3s://HostName:PortNumber

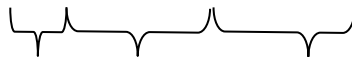

Protocol Host Name Weblogic Port

Protocol: This should be t3s as in WebLogic application server.

Server URL: This should be the IP address or fully qualified computer name (i.e. <computer name>.<domain>) of the system where the application server is running on which Gateway EJB has been deployed.

Port: This should be the same as **request port** mentioned in domain.xml file.

Edit following section in the <SPMLADAPTER_INSTALL_DIR>\OIM\FCUBSLOVAdService\config\ADOIM_Prop.xml file: (Change the values given in bold)

```
<add key="MAKER_ID" value="OIMUSER9"/>

<add key="HEAD_OFFICE" value="CHO"/>

<add key="REQ_SOURCE" value="IDM"/>

<add key="UBS_OR_IS" value="FCIS"/>

<add key="LOGGER_PATH"

value="D:/OIM/FCUBSProvisioningAdService/config/adoim_logger.xml"/>

<add key="FCUBS_SPML_ERROR_FILE"

value="D:/OIM/FCUBSProvisioningAdService/config/
FCUBS_SPML_ERROR.properties"/>

<add key="ADOIM_MSG_LOGGING_ENABLED" value="N"/>

<add key="ADOIM_MSG_LOGGING_PATH"

value="D:/OIM/FCUBSProvisioningAdService/log"/>
```

Edit MAKER_ID: Give FCIS user id that can serve as maker id for all OIM requests. Please ensure that this id should be a valid user in FCIS and should have rights for creating, authorizing and modifying user.

Edit HEAD_OFFICE: Give the head office branch code.

Edit REQ_SOURCE: Give the external source name. Please ensure that maintenance of this external source has been done in FCIS.

Edit UBS_OR_IS: Give the application name to which the user need to be provisioned. The value will be either FCUBS or FCIS.

Edit LOGGER_PATH: Give the logging configuration absolute path for adoim_logger.xml. This file is residing in <SPMLADAPTER_INSTALL_DIR>\OIM\FCUBSProvisioningAdService\config folder.

Edit FCUBS_SPML_ERROR_FILE: Give the absolute path for fcubs_spml_error.properties. This file is residing in <SPMLADAPTER_INSTALL_DIR>\OIM\FCUBSProvisioningAdService\config folder.

Edit ADOIM_MSG_LOGGING_ENABLED: Give 'Y' if OIM request and response message is required to be stored separately otherwise give 'N'.

Edit ADOIM_MSG_LOGGING_PATH: Give the absolute path where OIM request–response will get stored.

Note: As separator use forward slash instead of backward slash. Give "/" for at the end of the path.

Edit <SPMLADAPTER_INSTALL_DIR>\OIM\FCUBSProvisioningAdService\config\adoim_logger.xml. This XML file shall have a similar section as the one shown below, (Change the values given in bold)

```
<add key="ADOIM.LOGGER.FPATH" value="D:/OIM/FCUBSProvisioningAdService /log"/>
```

Edit ADOIM.LOGGER.FPATH: Give the absolute path where log files will be stored. It is recommended that mention the following path <SPMLADAPTER_INSTALL_DIR>/OIM/FCUBSProvisioningAdService/log/

Note: As separator use forward slash instead of backward slash. Give "/" for at the end of the path.

Remark: GW_EJB_SECURITY_PRINCIPAL & GW_EJB_SECURITY_CREDENTIALS can be update using <SPMLADAPTER_INSTALL_DIR>\OIM\FCUBSProvisioningAdService\setup\ChangePassword.bat or ChangePassword.sh

5.1.4.1.4 Building the Deployment Units for WINDOWS

5.1.4.1.4.1 Building FCUBSLOVAdService.ear

- Edit <SPMLADAPTER_INSTALL_DIR>\OIM\FCUBSLOVAdService\setup\WEBLOGIC\ build.xml to set {server_home} entry to Weblogic Server installed directory
- Eg: D:\Middleware\wlserver_10.3
- Open a DOS command-prompt and change directory to, D:\OIM\FCUBSLOVAdService\
- Set PATH to JDK\bin and ANT\bin in the command prompt
- Set JAVA_HOME
- Change the directory to D:\OIM\FCUBSLOVAdService\setup\WEBLOGIC
- To execute the build file, type "ant" on the command-prompt and press enter.

Above step creates an EAR file in D:\OIM\FCUBSLOVAdService\build with the name FCUBSLOVAdService.ear

5.1.4.1.4.2 Building FCUBSProvisioningAdService.ear

- Edit <SPMLADAPTER_INSTALL_DIR>\OIM\FCUBSProvisioningAdService\setup\WEBLOGIC\build.xml to set {server_home} and {JAVA_HOME} entry to Weblogic Server installed directory and JDK Installed directory.

Eg: D:\Middleware\wlserver_10.3

C:\Program Files\java\jdk1.7.0_51

- Change directory to, D:\OIM\FCUBSProvisioningAdService\setup\WEBLOGIC
- To execute the build file, type "ant" on the command-prompt and press enter.

Above step creates an EAR file in build D:\OIM\FCUBSProvisioningAdService folder with the name FCUBSProvisioningAdService.ear

5.1.4.1.5 Building the Deployment Units for UNIX / Linux

5.1.4.1.5.1 Building FCUBSLOVAdService.ear

- Modify {server_home} entry in the build.xml to where Weblogic Server is installed (for example /home/kernel/Middleware/wlserver_10.3)
- Open a UNIX shell prompt and change directory to, /home/OIM/FCUBSLOVAdService
- Set PATH environment variable with JDK/bin path and ANT\bin path in the command prompt.
- Change the directory to <SPMLADAPTER_INSTALL_DIR>/FCUBSLOVAdService/setup/WEBLOGIC
- To execute the build file, type “ant” on the shell prompt and press enter.

Above step creates an EAR file in /home/kernel/OIM/FCUBSLOVAdService/build folder with the name FCUBSLOVAdService.ear

5.1.4.1.5.2 Building FCUBSProvisioningAdService.ear

- Edit
<SPMLADAPTER_INSTALL_DIR>/OIM/FCUBSProvisioningAdService/setup/WEBLOGIC/build.xml
to set {server_home} entry to Weblogic Server installed directory

Eg: home/Oracle/Middleware/wlserver_10.3

home/java/jdk1.7.0_51

- Change directory to, /home/kernel/OIM/FCUBSProvisioningAdService/setup/WEBLOGIC
- To execute the build file, type “ant” on the command-prompt and press enter.

Above step creates an EAR file in /home/kernel/OIM/FCUBSProvisioningAdService/build folder with the name FCUBSProvisioningAdService.ear

5.1.4.2 Deployment

Deploy FCUBSLOVAdService

5.1.4.2.1 Login to Administrative Console

5.1.4.2.2 Enter Weblogic administrator username/password and press Login

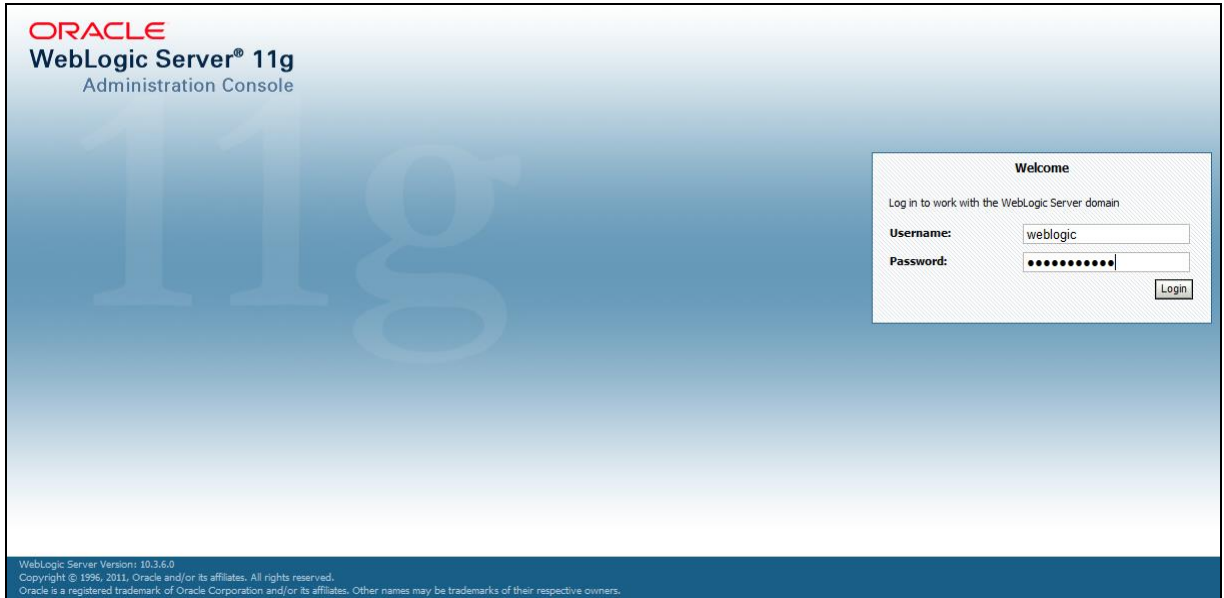

5.1.4.2.3 Click on Deployments as shown in below screen

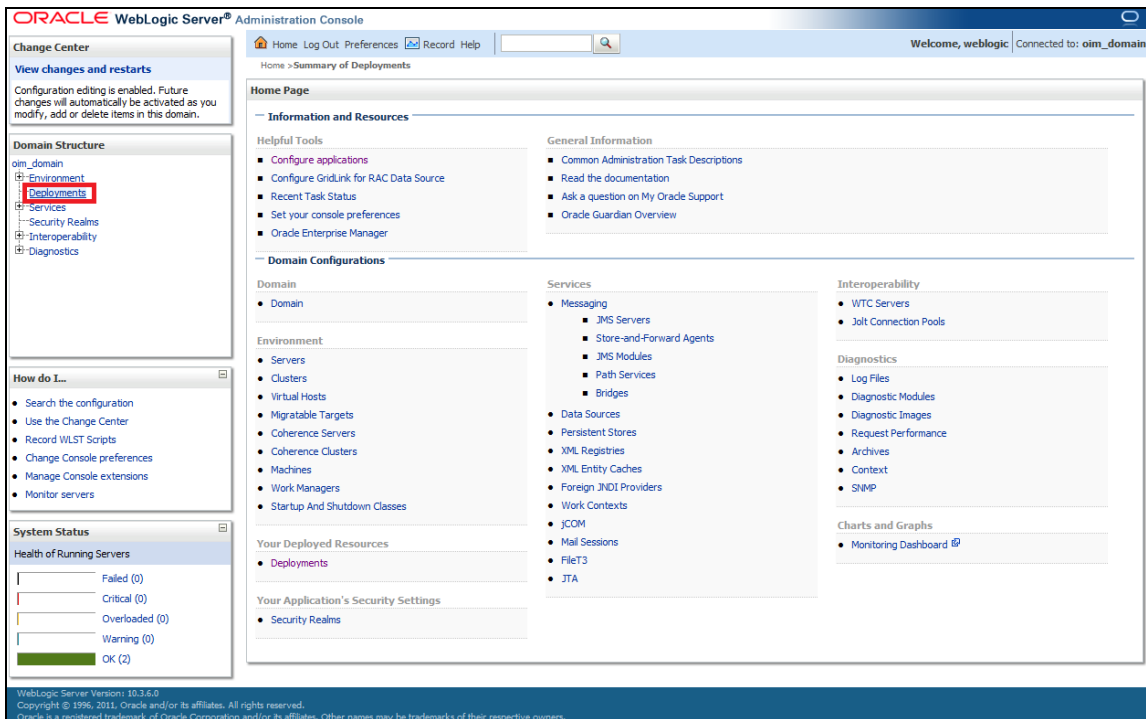

5.1.4.2.4 Click on the Install as shown below

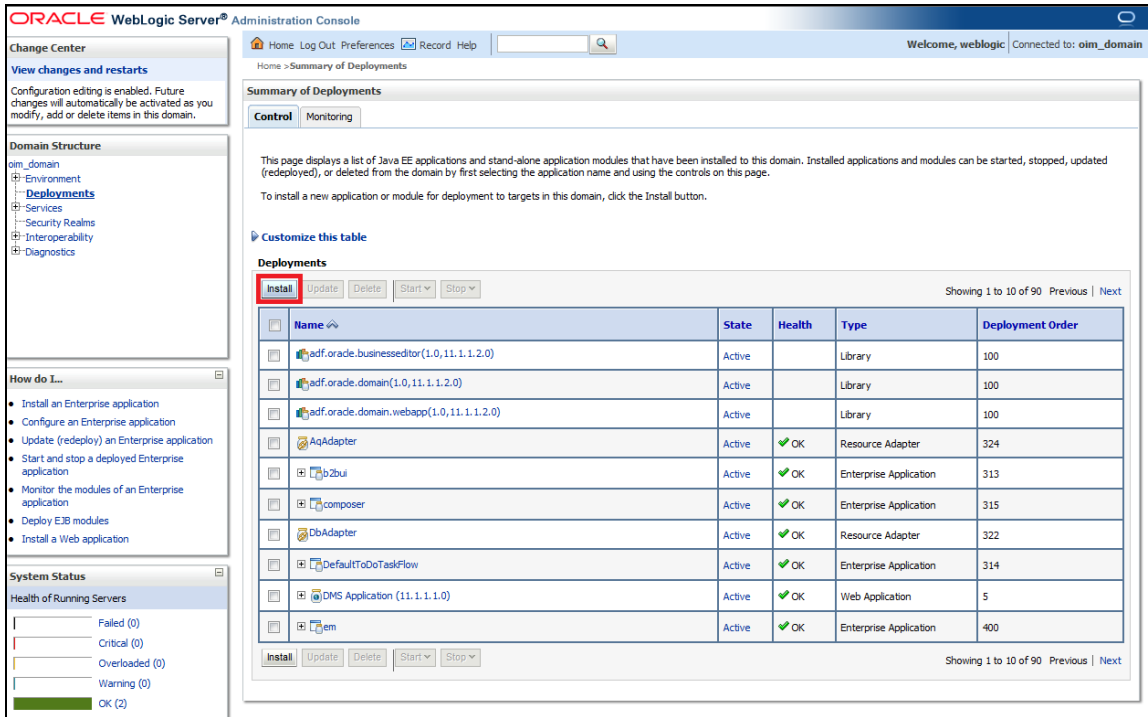

5.1.4.2.5 The following screen is displayed

a. Click on upload your file(s)

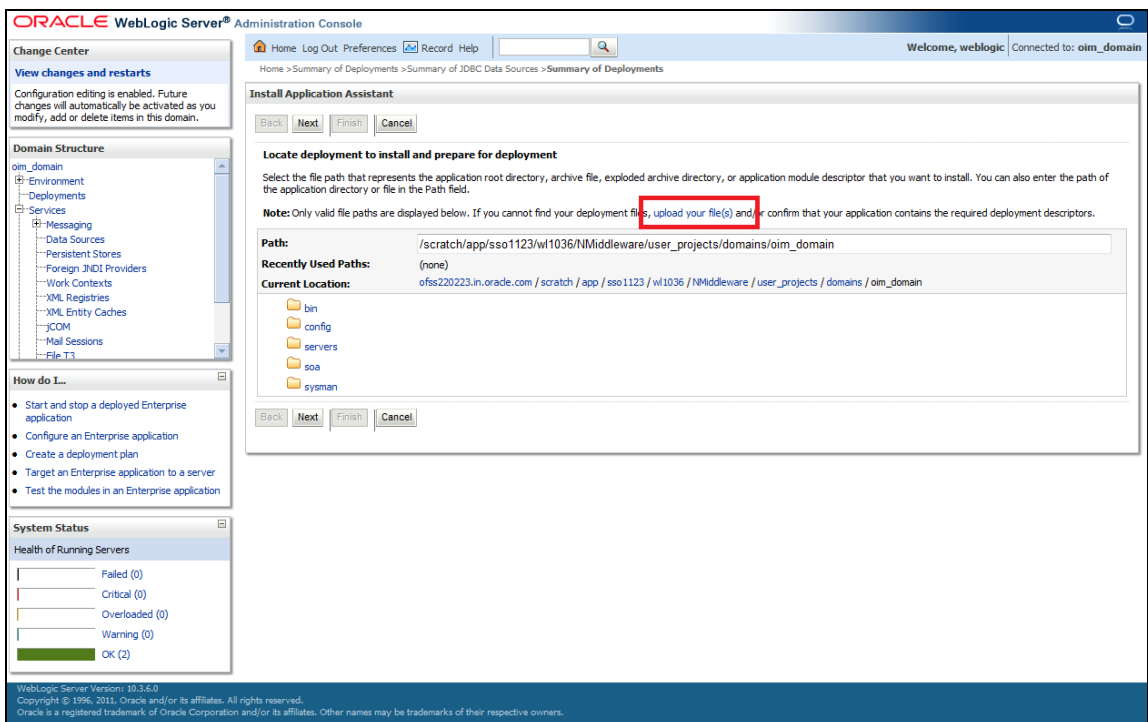

5.1.4.2.6 Choose the enterprise archive file from the build path:

<SPMLADAPTER_INSTALL_DIR>\OIM\FCUBSLOVAdService\build\

- a. Click on Next

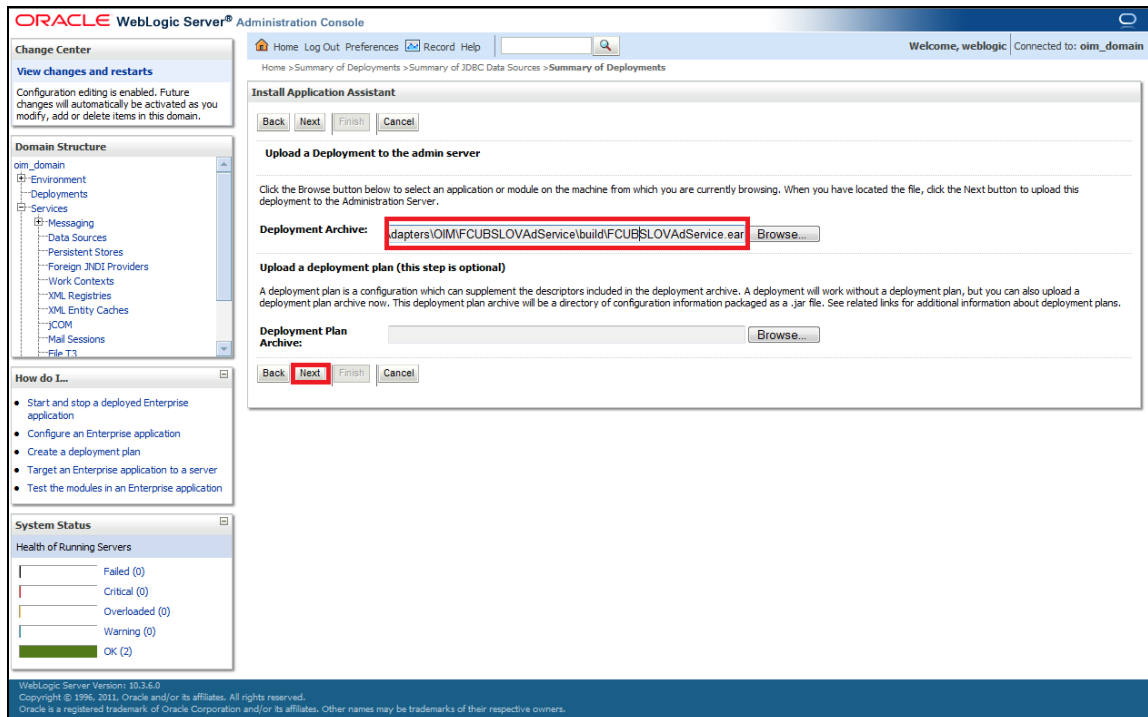

5.1.4.2.7 Select the enterprises archive file FCUBSLOVAdService.ear

- a. Click on Next

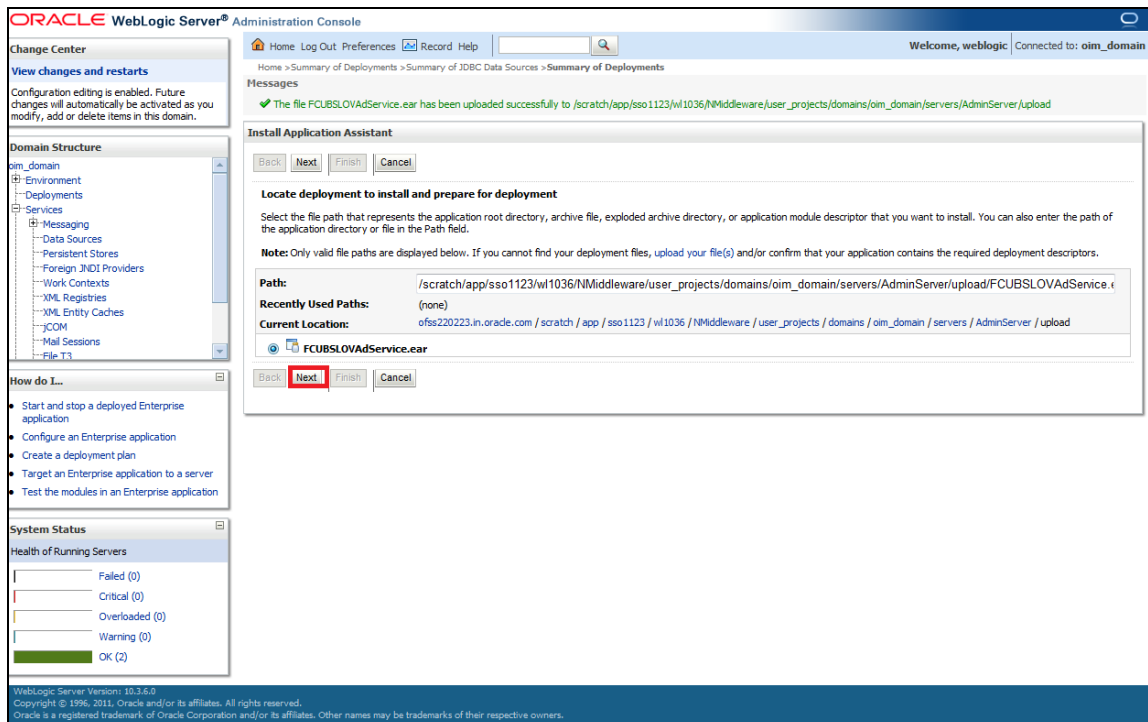

5.1.4.2.8 The following screen is displayed

- a. Select – Install this deployment as an application.
- b. Click on Next.

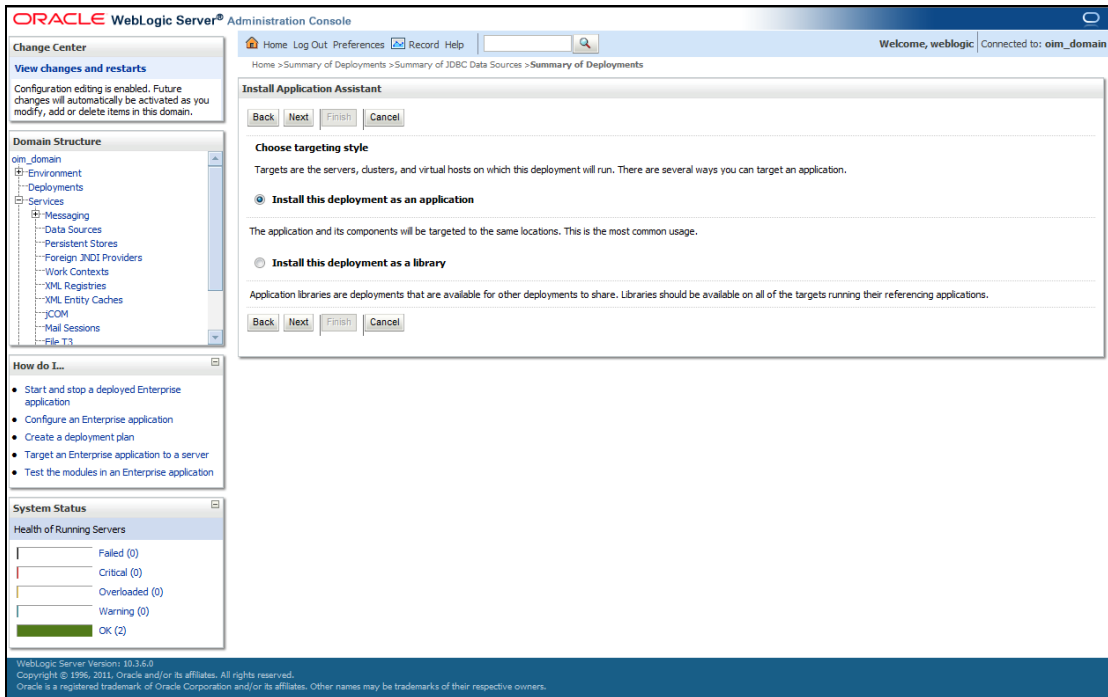

5.1.4.2.9 The following screen is displayed

- a. Select the Application Server Instance in which the FCUBSLOVAdService needs to be deployed.
- b. Click on Next.

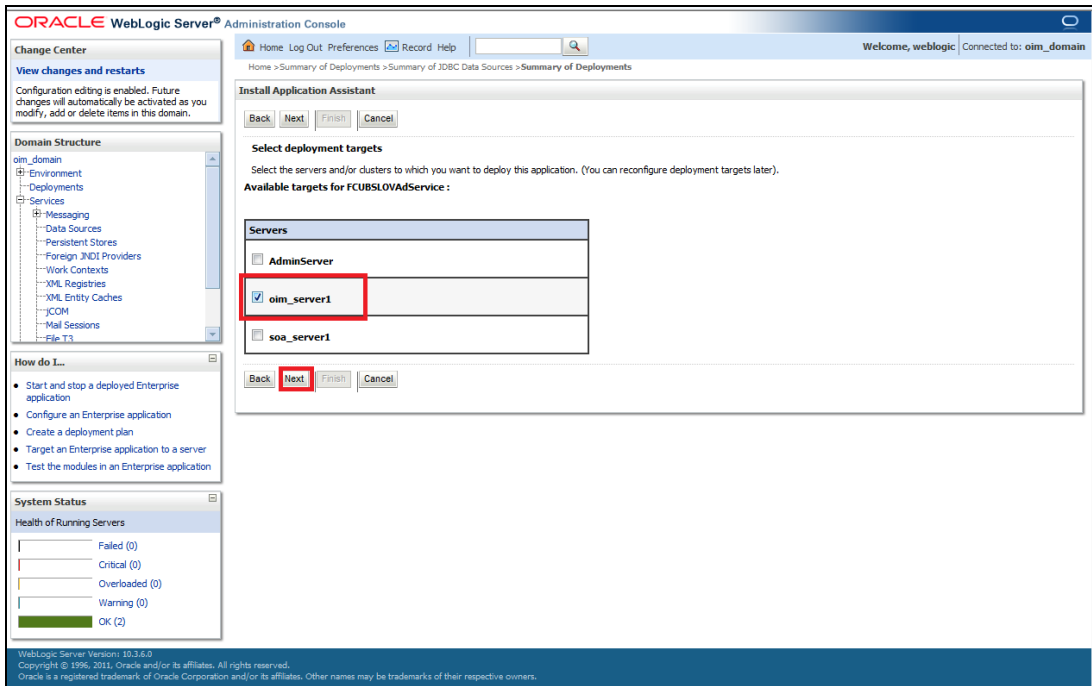

5.1.4.2.10 The following screen is displayed

- b. Click on Finish.

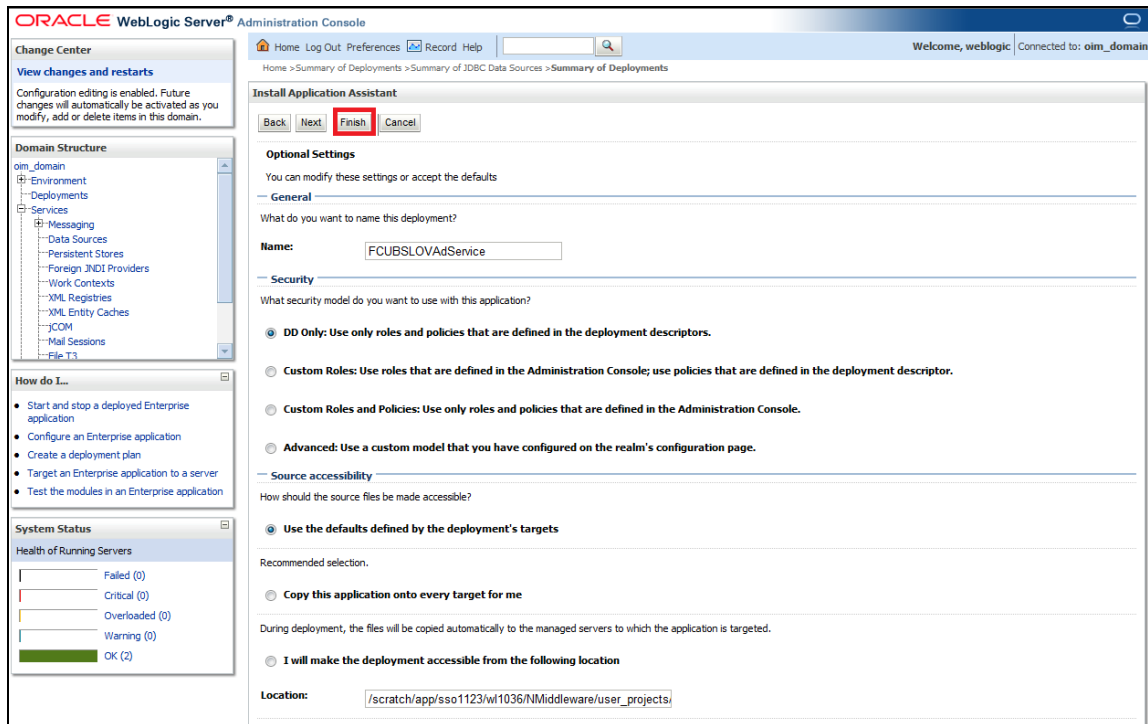

5.1.4.2.11 Deploy FCUBSProvisioningAdService

If the **GW_EJB_CALL_TYPE** is set as **REMOTE** in the **ADOIM_Prop.xml** then follow the same step as above (Section 5.1.4.2.1) to deploy the FCUBSProvisioningAdService web service with following changes

- Select the ear file from the path <SPMLADAPTER_INSTALL_DIR>\OIM\FCUBSProvisioningAdService\build\FCUBSProvisioningAdService.ear
- Give the application name as FCUBSProvisioningAdService.

If the **GW_EJB_CALL_TYPE** is set as **REMOTE** in the **ADOIM_Prop.xml**, follow the below steps

The following screen is displayed.

1. Make sure that Gateway EJB bean has been deployed there as shown in below screen shot.

The screenshot shows the Oracle WebLogic Server Administration Console. The main content area is titled "Summary of Deployments" and contains a table of deployed applications. The table has columns for Name, State, Health, Type, and Deployment Order. The application "GWEJB" is highlighted with a red box. Its state is "Active" and its health is "OK". The application structure is expanded to show its components: Modules (GW_EJB_Bean.jar), EJBs (GWEJB_GW_EJB_Bean), and Web Services.

| Name | State | Health | Type | Deployment Order |
|---|---------------|-----------|-------------------------------|------------------|
| emai | Active | | Library | 100 |
| emas | Active | | Library | 100 |
| emcore | Active | | Library | 100 |
| FCUBSLOVAdService | Active | OK | Enterprise Application | 100 |
| FileAdapter | Active | OK | Resource Adapter | 321 |
| FMW Welcome Page Application (11.1.0.0.0) | Active | OK | Enterprise Application | 5 |
| FtpAdapter | Active | OK | Resource Adapter | 325 |
| GWEJB | Active | OK | Enterprise Application | 100 |
| Modules | | | | |
| GW_EJB_Bean.jar | | | EJB Module | |
| EJBs | | | | |
| GWEJB_GW_EJB_Bean | | | EJB | |
| Web Services | | | | |
| None to display | | | | |

Refer 5.1.4.2.1 to know more about the deployment steps.

2. Choose the enterprise archive file Path from the build path:

<SPMLADAPTER_INSTALL_DIR>\OIM\FCUBSProvisioningAdService\build\

3. Select the enterprises archive file FCUBSProvisioningAdService.ear

4. Click on Finish.

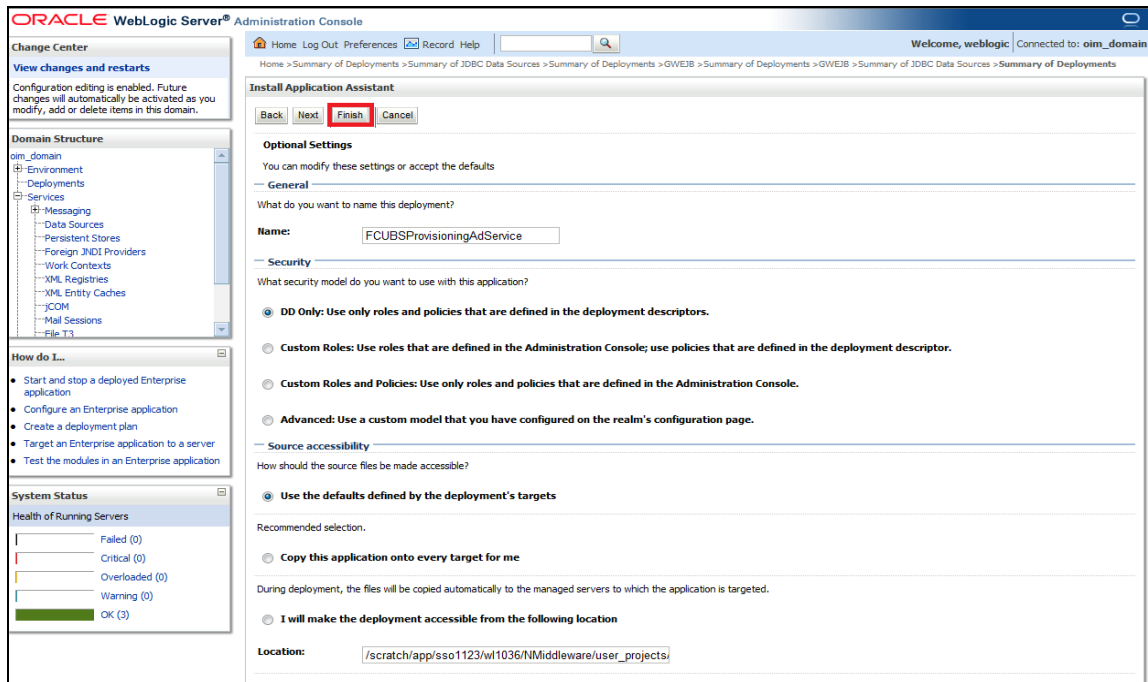

5.1.5 Build GWEJB

- To execute the FCIS Installer for GWEJB build following folder/files should be created/copied at **\\ADAPTERS\OIM\FCUBSGW** along with the compiled sources.
- MAIN (Blank folder)
- FCHome.ini (copy from OSDC sources, file will be present at parallel to ADAPTERS folder)
-
- After this GWEJB ear can be build with the source location as **\\ADAPTERS\OIM\FCUBSGW** .
- For GWEJB build kindly refer the doc **Gateway_EAR_Building.doc**.

Deploy the created GWEJB ear in OIM server.

5.1.6 OIM Setup

Prerequisite: Oracle Identity Server & Oracle Design Console.

OIM side setup should be done on the system where OIM server is running. This setup includes

Java code deployment of OIM's pre-populate adapter, entity adapter and schedule task & importing integration specific configuration files into OIM.

The following steps to be followed to do the initial environment setup:

5.1.6.1 **Copy following folders from the FCIS Software Release area**

- <FCIS Release Name>\ADAPTERS\OIM\OIM-Config
- <FCIS RELEASE NAME>\ADAPTERS\OIM\setup

to local machine (say D:\OIM for WINDOWS or /home/kernel/OIM for UNIX).

5.1.6.2 Building the Lookup Search Scheduled Task deployment units for WINDOWS.

- Change directory to, D:\OIM\OIM-Config\Sch-Task\setup
- Modify the OIM_SERVER_INSTALL_DIR entry in the build.xml to where OIM Server is installed (for example D:\Oracle\Middleware\weblogic\Oracle_IDM1) and JAVA_HOME entry.
- In the below section of build.xml change the WSDL location hostname and port.

```
<exec executable="{JAVA_HOME}/bin/wsimport">  
  
<arg line="-keep -p com.iflex.fcubs.integration.oim.ws.client http://  
<hostname>:<port>/FCUBSLOVAdService/FCUBSLOVAdServiceSEI?WSDL"/>  
  
</exec>
```

- To execute the build file, type “ant” on the command-prompt and press enter.

Above step creates a JAR file in D:\OIM\OIM-Config\Sch-Task\build\ FCUBSLOVSchTask folder with the name **FCUBSLOVSchTask.Jar**

- Copy this FCUBSLOVSchTask.Jar to the <OIM_SERVER_INSTALL_DIR>\server\ScheduleTask folder and <OIM_SERVER_INSTALL_DIR>\server\apps\oim.ear\APP-INF\lib

5.1.6.3 Building the Lookup Search Scheduled Task deployment units for UNIX

- Change directory to /home/kernel/OIM/OIM-Config/Sch-Task/setup
- Modify the OIM_SERVER_INSTALL_DIR entry in the build.xml to where OIM Server is installed (for example /Oracle/Middleware/weblogic/Oracle_IDM1) and JAVA_HOME entry.
- In the below section of build.xml change the WSDL location hostname and port.

```
<exec executable="{JAVA_HOME}/bin/wsimport">  
  
<arg line="-keep -p com.iflex.fcubs.integration.oim.ws.client  
http://<hostname>:<port>/FCUBSLOVAdService/FCUBSLOVAdServiceSEI?WSDL"/>  
  
</exec>
```

- To execute the build file, type “ant” on the shell and press enter.

Above step creates a JAR file in /home/kernel/OIM/OIM-Config/Sch-Task/build/FCUBSLOVSchTask folder with the name **FCUBSLOVSchTask.Jar**

- Copy this FCUBSLOVSchTask.Jar to the <OIM_SERVER_INSTALL_DIR>/server/ScheduleTask folder and <OIM_SERVER_INSTALL_DIR>/server/apps/oim.ear/APP-INF/lib

5.1.6.4 Deployment of Pre-population Adapters

Below Steps will be valid In case of different name used to create the form in [5.1.5.35](#)

- Change the directory to

```
<AdapterSource>/OIM/OIM-Config/PrePopulateAdapter
```

- Edit the plugin.xml and update the FlexcubeForm into the form name entered in [5.1.5.35](#)

```
<?xml version="1.0" encoding="UTF-8" ?>

<oimplugins xmlns:xsi="http://www.w3.org/2001/XMLSchema-instance">

<plugins pluginpoint="oracle.iam.request.plugins.PrePopulationAdapter">

<plugin pluginclass="com.oracle.oim.utility.eventhandler.UserIDPrepopulateAdapter" version="1.0"

    name="UserIDPrepopulateAdapter">

<metadata name="PrePopulationAdapater">

<value>FlexcubeForm::USERID</value>

</metadata>

</plugin>

<plugin pluginclass="com.oracle.oim.utility.eventhandler.UserNamePrepopulateAdapter" version="1.0"

    name="UserNamePrepopulateAdapter">

<metadata name="PrePopulationAdapater">

<value>FlexcubeForm::USERNAME</value>

</metadata>

</plugin>

<plugin pluginclass="com.oracle.oim.utility.eventhandler.UserPasswordPrepopulateAdapter" version="1.0"

    name="UserPasswordPrepopulateAdapter">

<metadata name="PrePopulationAdapater">

<value>FlexcubeForm::USERPASSWORD</value>

</metadata>

</plugin>

<plugin pluginclass="com.oracle.oim.utility.eventhandler.EmailPrepopulateAdapter" version="1.0"

    name="EmailPrepopulateAdapter">

<metadata name="PrePopulationAdapater">

<value>FlexcubeForm::EMAIL</value>

</metadata>
```



```

</plugin>

<plugin pluginclass="com.oracle.oid.utility.eventhandler.LdapUserPrepopulateAdapter" version="1.0"
    name="LdapUserPrepopulateAdapter">
    <metadata name="PrePopulationAdapter">
    <value>FlexcubeForm::LDAPUSR</value>
    </metadata>
</plugin>

<plugin pluginclass="com.oracle.oid.utility.eventhandler.StartDatePrepopulateAdapter" version="1.0"
    name="StartDatePrepopulateAdapter">
    <metadata name="PrePopulationAdapter">
    <value>FlexcubeForm::STARTDATE</value>
    </metadata>
</plugin>
</plugins>

<plugins pluginpoint="oracle.iam.platform.kernel.spi.EventHandler">

<plugin pluginclass="com.oracle.oid.utility.eventhandler.UserPasswordPreProcessHandler" version="1.0"
    name="UserPasswordPreProcessHandler"></plugin>

</plugins>

</oimplugins>

```

- Change the directory to

```
<AdapterSource>/OIM/OIM-Config/PrePopulateAdapter /setup
```

- Modify the OIM_SERVER_INSTALL_DIR entry in the build.xml to where OIM Server is installed (for example D:\Oracle\Middleware\weblogic\Oracle_IDM1) and JAVA_HOME entry
- To execute the build file, type "ant" on the shell and press enter.

Above step creates a zip file in <AdapterSource>/OIM/OIM-Config/PrePopulateAdapter/build/ folder with the name **prepopulateadapter.zip**

- Copy the <AdapterSource>/OIM/OIM-Config/PrePopulateAdapter/build/prepopulateadapter.zip into <OIM_SERVER_INSTALL_DIR>/server/plugins/
- <OIM_SERVER_INSTALL_DIR>/server/plugin_utility/ant.properties should be changed from

```
#####  
## The installation directory for WLS or WAS  
  
#####  
#wls.home=@wls_home  
  
#was.home=@was_home  
  
#####  
# The OIM server directory for OIM. For example: MW_HOME/Oracle_IDM1/server  
  
#####  
#oim.home@oim_home  
  
#####  
#login file name with path for WAS or WLS  
  
#####  
#login.config=${oim.home}/config/authwl.conf  
  
#login.config=${oim.home}/config/authws.conf  
  
#####  
# Represents the directory where Oracle Fusion Middleware is installed.  
  
#####  
#mw.home=@mw_home
```

To

```
#####  
## The installation directory for WLS or WAS  
#####  
wls.home=<Installation_DIR>/Middleware/wlserver_10.3  
#was.home=@was_home  
  
#####  
# The OIM server directory for OIM. For example: MW_HOME/Oracle_IDM1/server  
#####  
oim.home=<OIM_INSTALLATION_DIR>/server/  
  
#####  
#login file name with path for WAS or WLS  
#####  
login.config=${oim.home}/config/authwl.conf  
#login.config=${oim.home}/config/authws.conf  
  
#####  
# Represents the directory where Oracle Fusion Middleware is installed.  
#####  
mw.home=<Installation_DIR>/Middleware
```

- Set the ANT_HOME & JAVA_HOME
 - In Command Prompt / SHELL type the below command and Press Enter
 - ant -f pluginregistration.xml register
 - Following Information has to be provided
 - > OIM Admin User – xelsysadm
 - > OIM Admin User – Password
 - > OIM Admin server URL : t3://hostname:portname
- e.g :: t3://whf00bmc.in.oracle.com:14000
- > Full path of adapter which needs to be imported
<OIM_SERVER_INSTALL_DIR>/server/plugins/prepopulateadapter.zip

- Result will be displayed like

Plugin com.oracle.oim.utility.eventhandler.LdapUserPrepopulateAdapter version 1.0 Registered

Plugin com.oracle.oim.utility.eventhandler.UserIDPrepopulateAdapter version 1.0 Registered

Plugin com.oracle.oim.utility.eventhandler.StartDatePrepopulateAdapter version 1.0 Registered

Plugin com.oracle.oim.utility.eventhandler.UserNamePrepopulateAdapter version 1.0 Registered

Plugin com.oracle.oim.utility.eventhandler.UserPasswordPrepopulateadapter version 1.0 Registered

Plugin com.oracle.oim.utility.eventhandler.EmailPrepopulateAdapter version 1.0 Registered

Plugin com.oracle.oim.utility.eventhandler.UserPasswordPreProcessHandler version 1.0 Registered

- Modify the weblogic.properties under < OIM_SERVER_INSTALL_DIR >/server/bin

```
wls_servername=@servername
application_name=@appname
metadata_from_loc=@metadata_from_loc
```

to

```
wls_servername=oim_server1
application_name=OIMMetadata
metadata_from_loc=<AdapterSource>/OIM/OIM-Config/PrePopulateAdapter/oim
```

- Type **sh weblogicImportMetadata.sh** in shell or **weblogicImportMeteData.bat** in command prompt and press enter to execute the command.
- You have to enter Weblogic Admin Server – user name, password and URL (like t3://localhost:7001)
- Type **sh PurgeCache.sh all** in shell or **PurgeCache.bat all** in command prompt and press enter to execute the command.
- Now you have to enter oim admin user name (xelsysadm), password and oim server URL (like t3://localhost:14000)
- Restart the OIM Server to impact the changes done.

5.1.6.5 Create folders for Reconciliation

- For reconciliation, there should be different folder for staging files (yet to be reconciled) and for processed files (after reconciliation). These folders can be anywhere that OIM should be able to access. If it is other than the OIM server system then that network path should be mapped as network drive.
- Create folder to keep staging file, for example

<OIM_SERVER_INSTALL_DIR>\xellerate\GTC\Recon\Staging

- Create folder to keep processed file, for example

<OIM_SERVER_INSTALL_DIR>\xellerate\GTC\Recon\Archive

5.1.6.6 Importing Configuration Files

This step involves import of integration specific configuration files into OIM using OIM provided Deployment Manager.

Prerequisite: Ensure that OIM setup steps have been followed properly.

Note: Do the import in the same order as it is described below.

Open the Oracle Identity Manager Administrative console. (Give the following URL in the browser: `http://<hostname>:<oimport>/sysadmin`)

5.1.6.7 Login to Administrative Console

5.1.6.8 Enter OIM administrator username/password and press Sign In

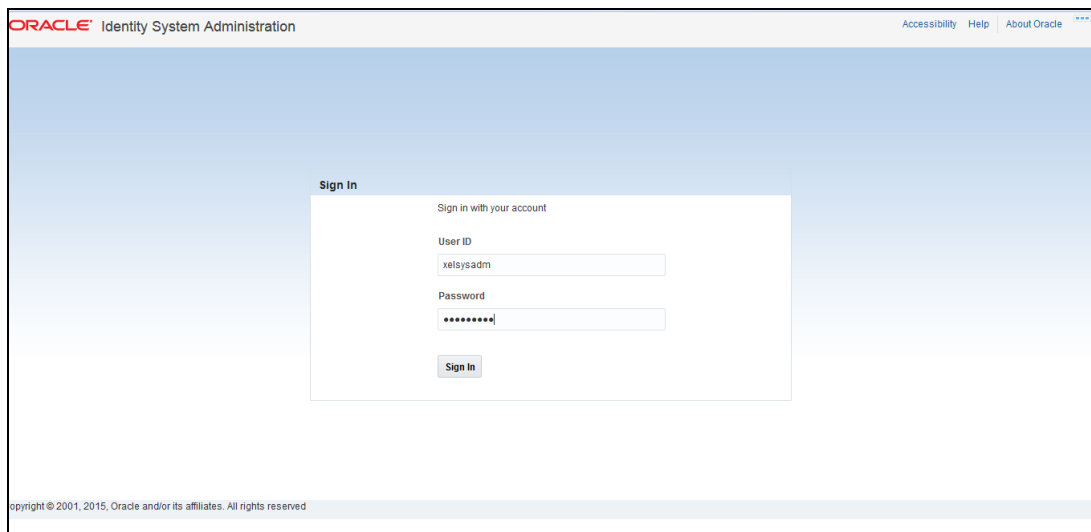

The screenshot shows the Oracle Identity System Administration web interface. The page title is "ORACLE Identity System Administration". In the center, there is a "Sign In" form with the following fields and elements:

- Text: "Sign in with your account"
- Text: "User ID"
- Text input field: "xelsysadm"
- Text: "Password"
- Text input field: "*****"
- Button: "Sign In"

At the bottom left, there is a copyright notice: "Copyright © 2001, 2015, Oracle and/or its affiliates. All rights reserved."

5.1.6.9 Click on Import option under System Configuration

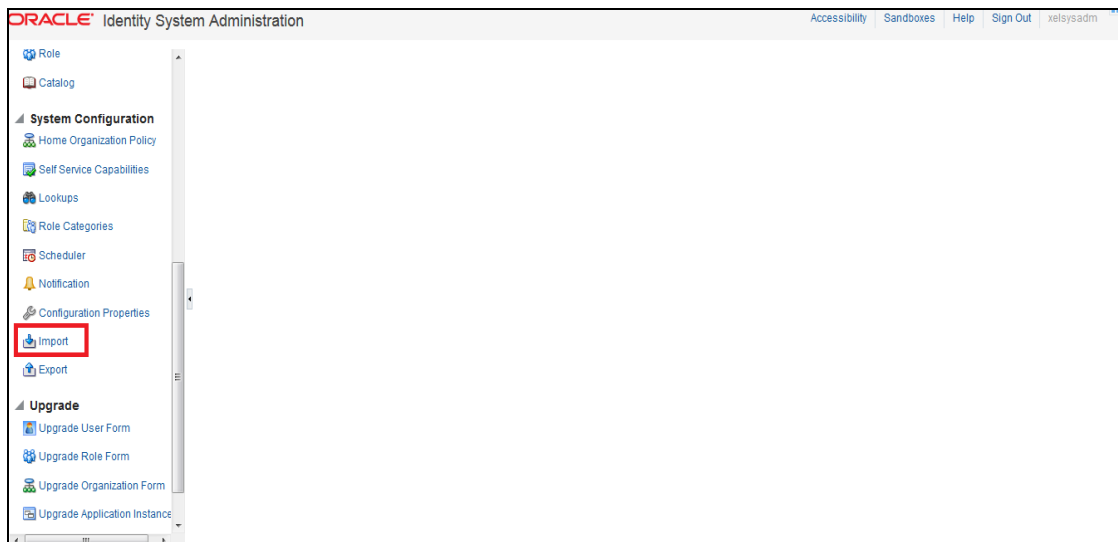

5.1.6.10 The following screen will get displayed with Add File option

- a. Select Lookup.xml file from the folder <SPMLADAPTER_INSTALL_DIR>\OIM\OIM-Config\Screens-Config.
- b. Click on Open.

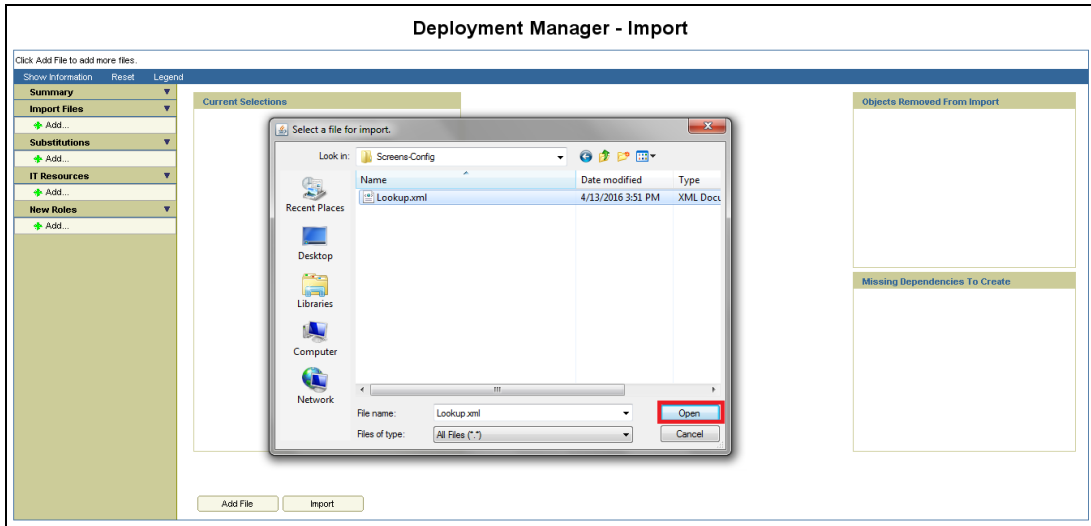

5.1.6.11 We will get File preview screen

- a. Click on Add file.

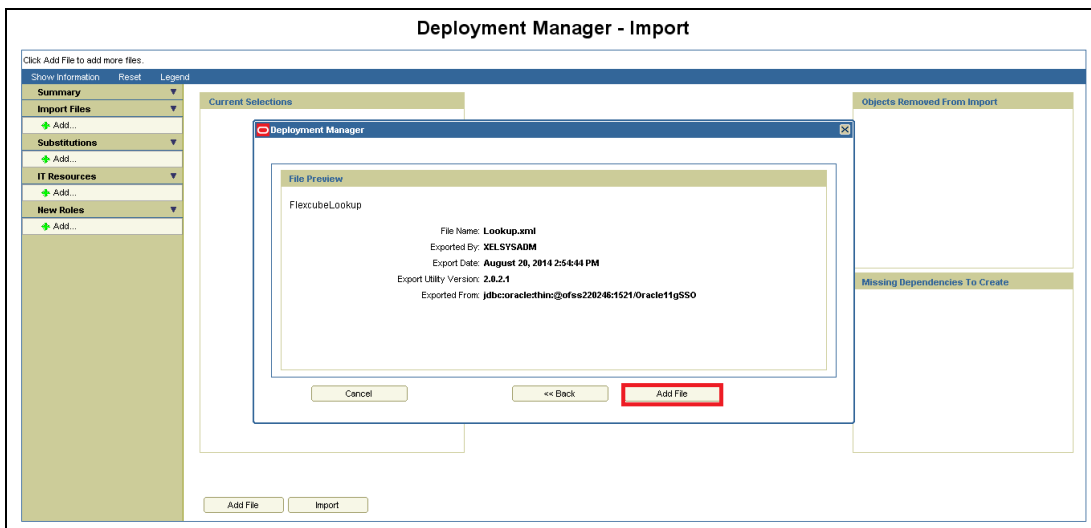

5.1.6.12 Click on Add File

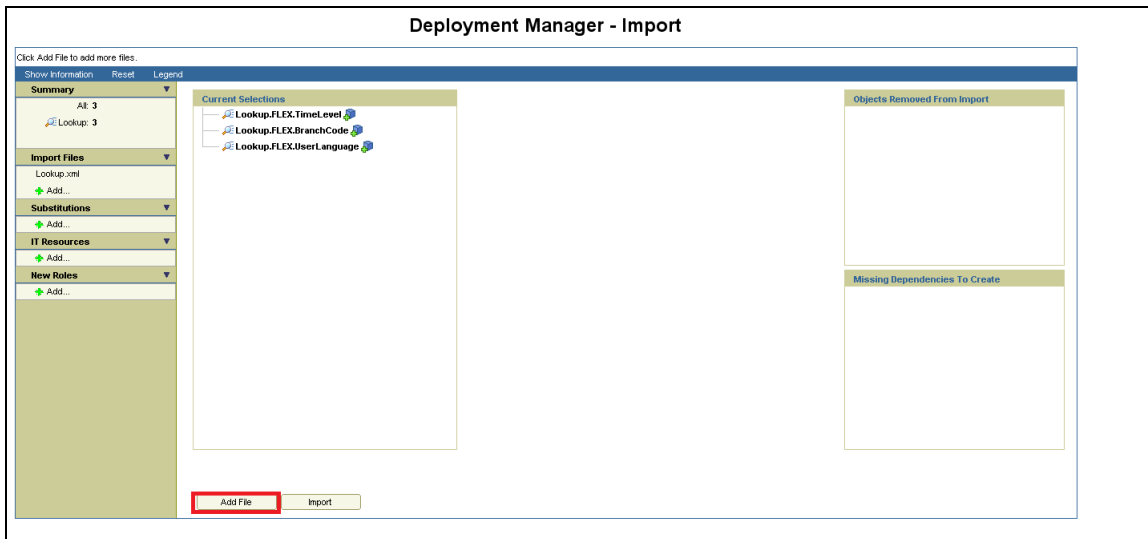

5.1.6.13 Select SchTask.xml file from the folder

<SPMLADAPTER_INSTALL_DIR>\OIM\OIM-Config\Sch-Tasks\Config-XML.

- a. Click on Open.

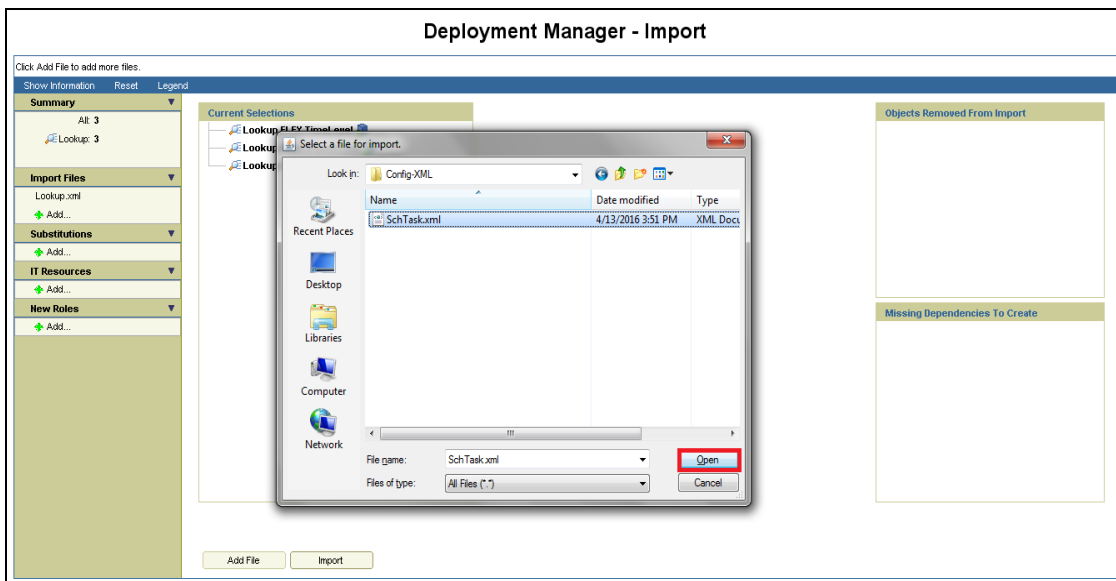

5.1.6.14 We will get File preview screen

- a. Click on Add file.

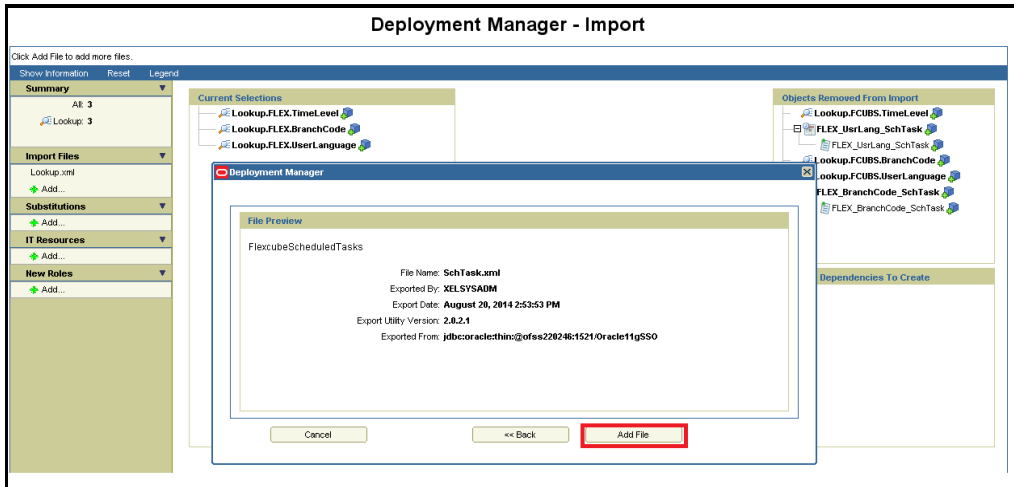

5.1.6.15 Click on Import

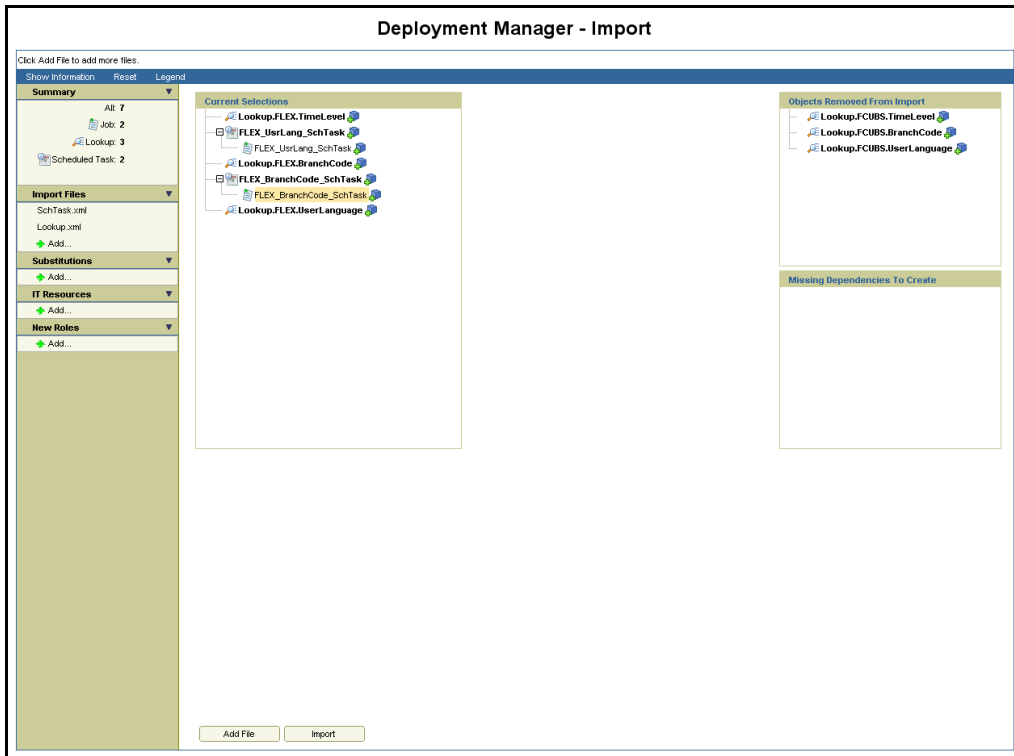

5.1.6.16 Above will prompt for Import Confirmation

- a. Click on Import to start import.

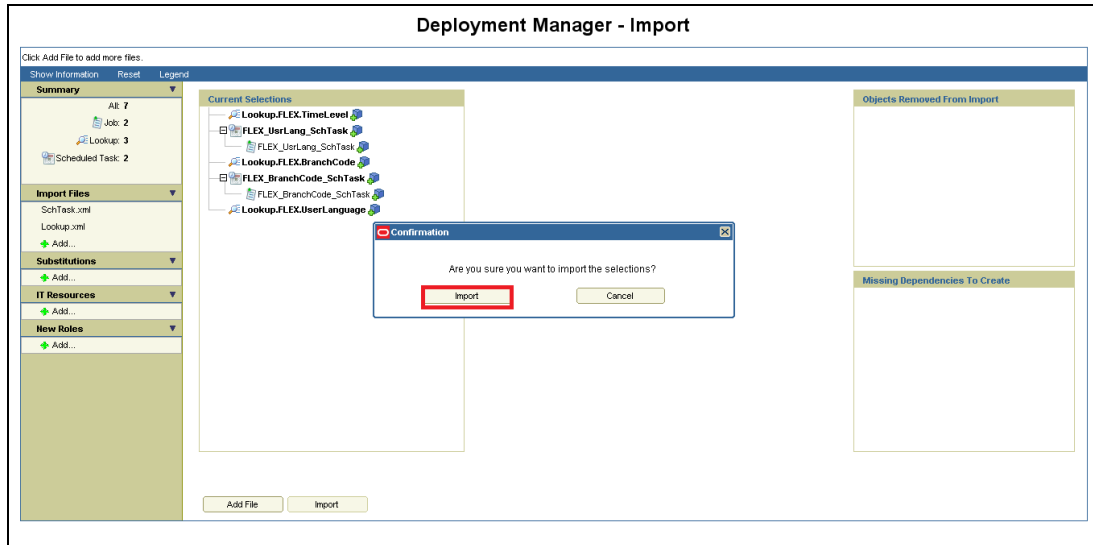

5.1.6.17 On successful import following screen will come

- a. Ensure that import is successful and click on ok.

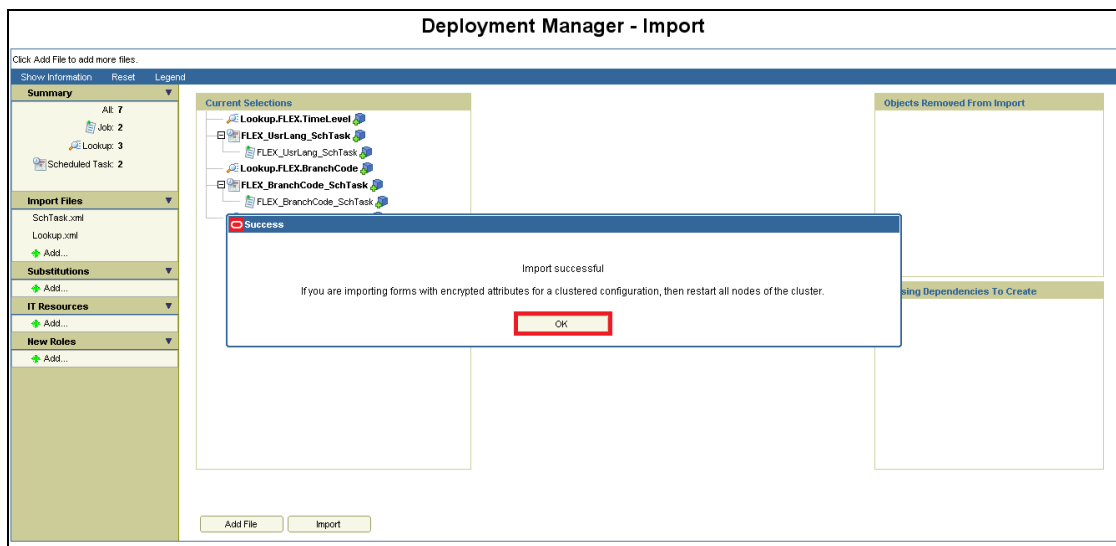

5.1.6.18 The following screen will get displayed.

- a. Click on Add File.

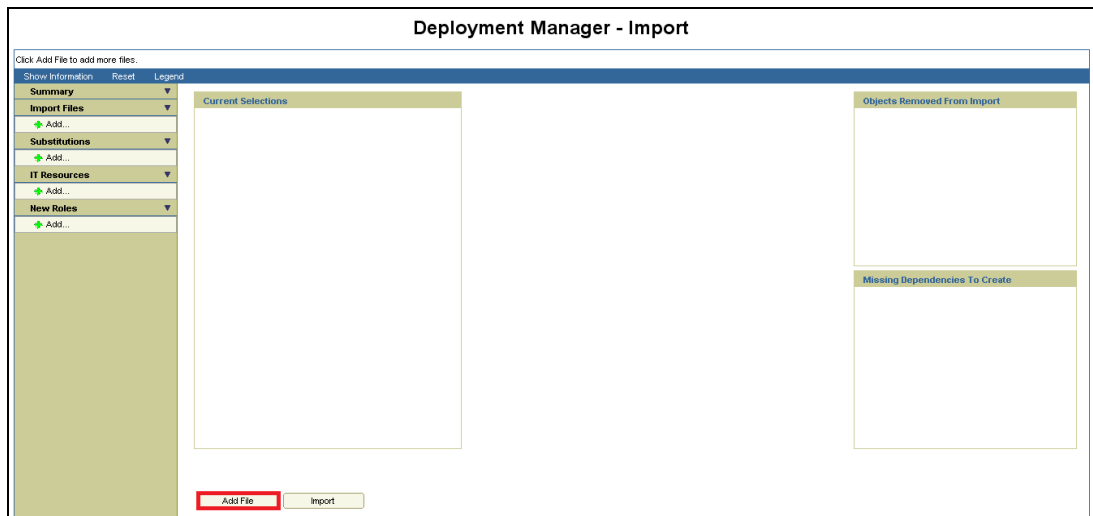

5.1.6.19 Open file window will get appeared

- b. Select GTC.xml file from the folder <SPMLADAPTER_INSTALL_DIR>\OIM\OIM-Config\GTC-Config\.
- c. Click on Open.

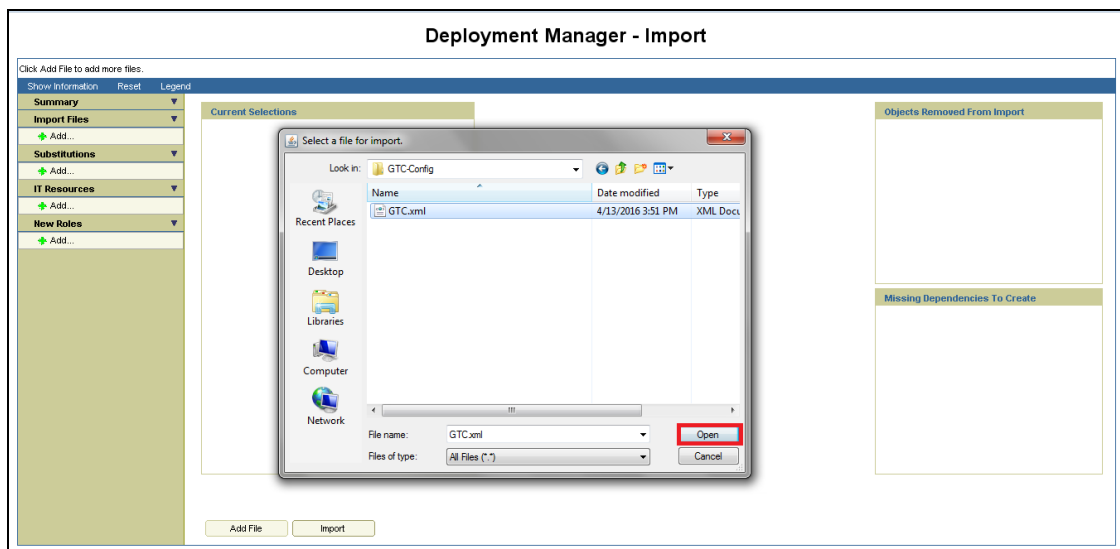

5.1.6.20 We will get File preview screen

- d. Click on Add file.

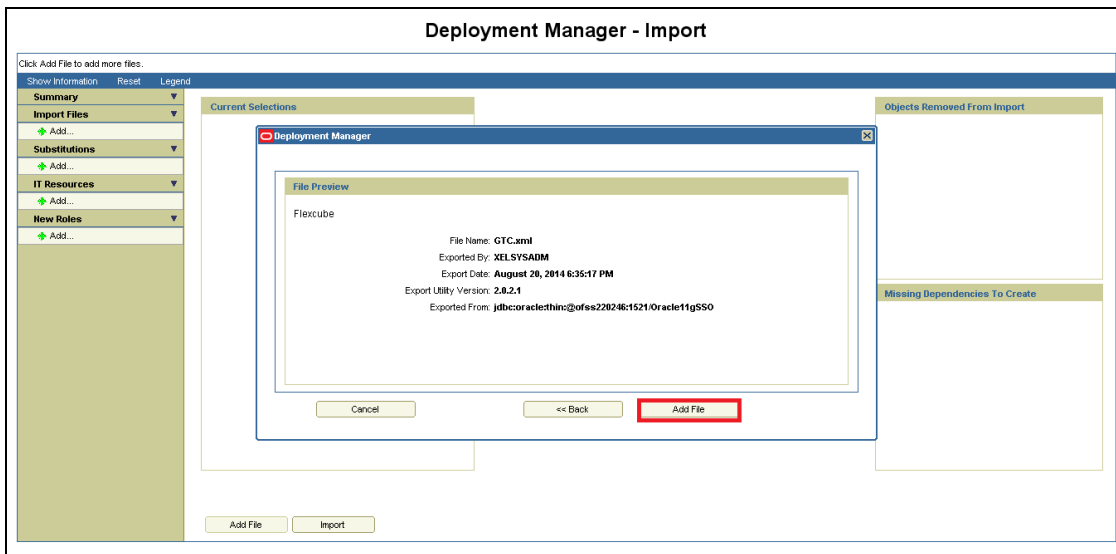

5.1.6.21 Next screen will be the substitution screen.

- e. If the GTC is imported first time then click on Next.
- f. If GTC have been already imported once successfully, change the Version name for example UD_FLEXCUBE Version = FLEXCUBE V2.
- g. Click on Next.

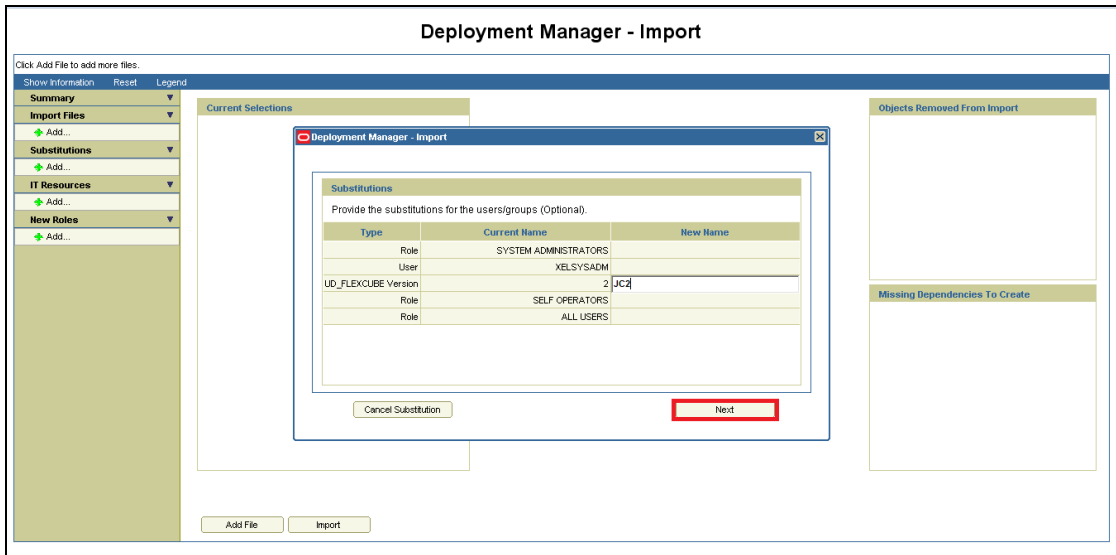

5.1.6.22 Above will prompt for substitution Confirmation

- h. If any value has been changed on previous screen it will list those substitution otherwise below screen will get displayed. Click on Next.

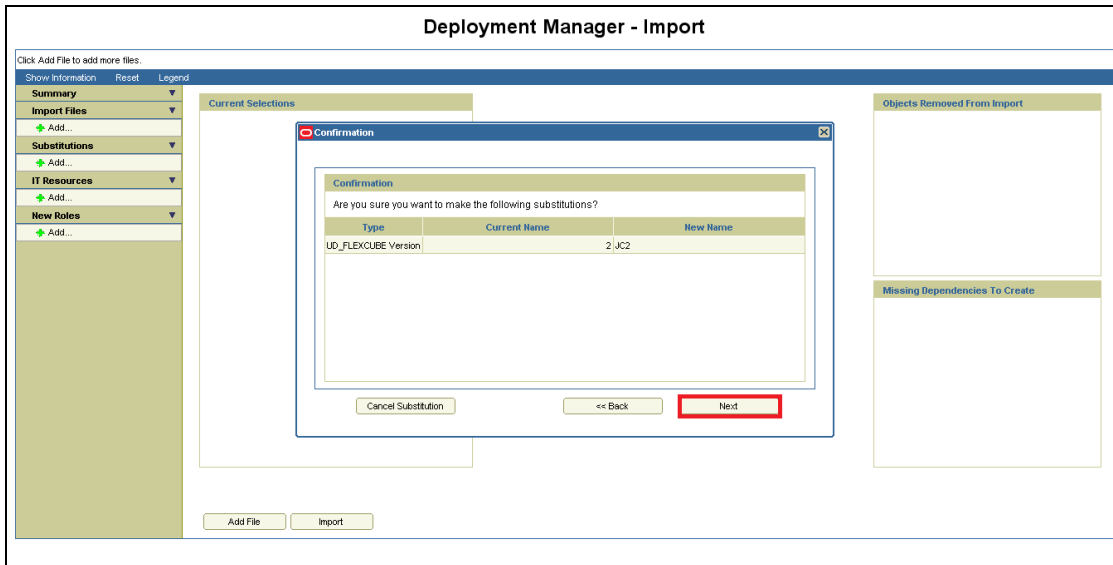

5.1.6.23 Next, Provide IT resource instance data screen will get displayed.

- i. Ensure that the green arrow should point to FLEXCUBE_GTC.
- j. Provide followings to the right hand table:

| Parameter Name | Parameter Value |
|----------------------------|--|
| SPML_targetID | Oracle FLEXCUBE |
| SharedDrive_filePrefix | SMOIMHOFF |
| SharedDrive_stageDirParent | Full path of the staging folder created in step 4 of OIM setup Eg: /home/Oracle/Oracle/Middleware/FCUBS-OIM-Config/Staging |
| Webservices_webserviceURL | Provisioning web service FCUBSProvisioningAdService URL deployed in step . Typically it should be like https://<hostName>:<port>/FCUBSProvisioningAdService/FCUBSProvisioningAdServiceSEI Eg: https://ofss000000:14001/FCUBSProvisioningAdService/FCUBSProvisioningAdServiceSEI |
| SharedDrive_archiveDir | Full path of the archiving folder created in step 4 of OIM setup Eg: /home/Oracle/Oracle/Middleware/FCUBS-OIM-Config/Archive |

| | |
|------------------------------|------------|
| SharedDrive_delimeter | , [Comma] |
| SharedDrive_uniqueAttrParent | USERID |

k. Click on Next.

Deployment Manager

Provide IT Resource Instance Data.

FLEXCUBE_GTC

FLEXCUBE_GTC
 << New Instance >>

| FLEXCUBE_GTC | |
|------------------------------|----------------------------------|
| Parameter Name | Parameter Value |
| SharedDrive_uniqueAttrParent | USERID |
| SPML_userName | |
| SPML_targetID | FLEXCUBE |
| WebServices_webServiceURL | https://ofss220607.in.oracle.com |
| SPML_userPassword | |
| SharedDrive_stageDirParent | /scratch/work_area/DBG/C |
| SharedDrive_stageDirMultival | |
| SharedDrive_fixedWidth | |
| SharedDrive_archiveDir | /scratch/work_area/DBG/C |
| Timestamp | |

Cancel IT Resource Modification << Back Skip **Next**

Deployment Manager

Provide IT Resource Instance Data.

FLEXCUBE_GTC

FLEXCUBE_GTC
 << New Instance >>

| FLEXCUBE_GTC | |
|---------------------------------|----------------------------------|
| Parameter Name | Parameter Value |
| WebServices_webServiceURL | https://ofss220607.in.oracle.com |
| SPML_userPassword | |
| SharedDrive_stageDirParent | /scratch/work_area/DBG/C |
| SharedDrive_stageDirMultival | |
| SharedDrive_fixedWidth | |
| SharedDrive_archiveDir | /scratch/work_area/DBG/C |
| Timestamp | |
| SharedDrive_delimeter | , |
| SharedDrive_whetherTabDelimited | |
| SharedDrive_filePrefix | SMOIMHOFF |

Cancel IT Resource Modification << Back Skip **Next**

5.1.6.24 The following screen will get displayed

- I. Click on Skip.

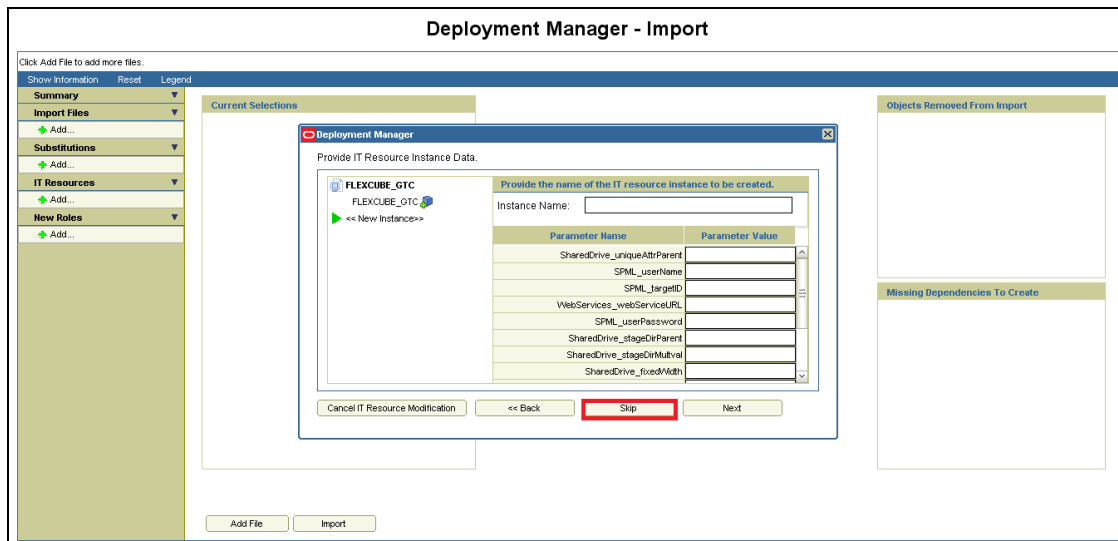

5.1.6.25 A confirmation window for parameter values will get displayed

- m. Confirm the values and click on View Selections.

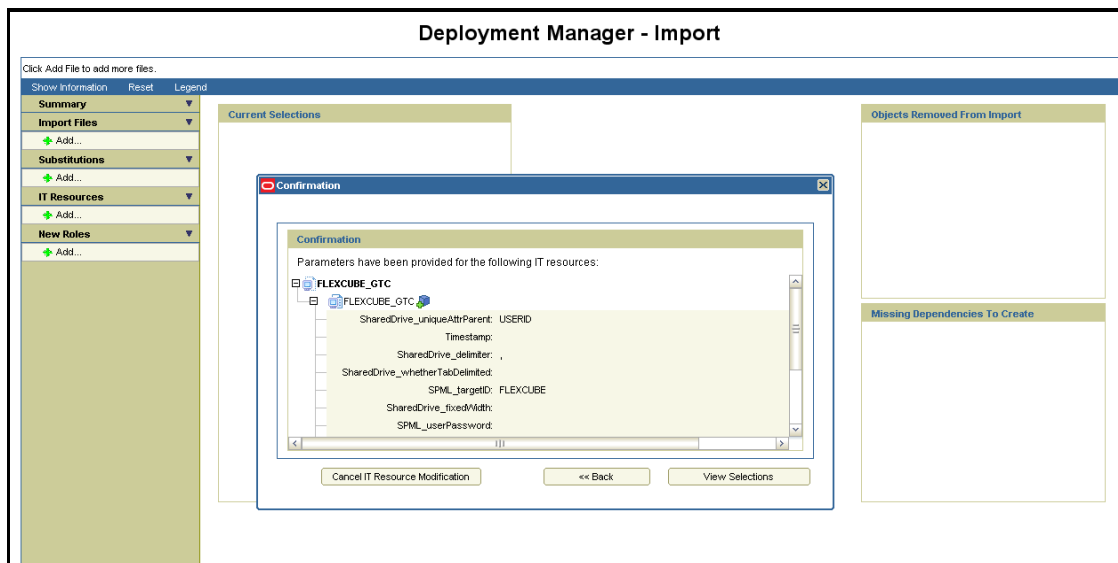

5.1.6.26 We will get Selection screen that will show all components of GTC

- n. Make sure that there should be no items in Missing Dependencies to create box on right below of the screen. If so, probably some previous imports has been missed out or not imported successfully. Repeat the earlier imports again.
- o. Otherwise click on Import.

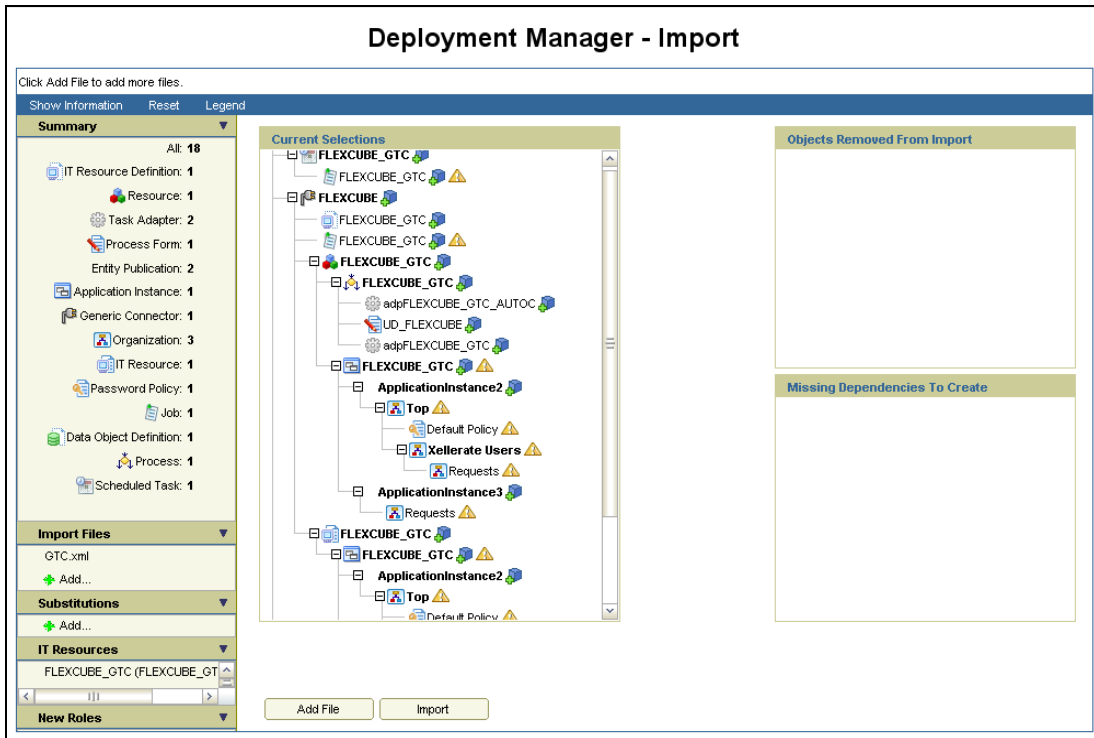

5.1.6.27 Above will prompt for Import Confirmation

- p. Click on Import to start import.

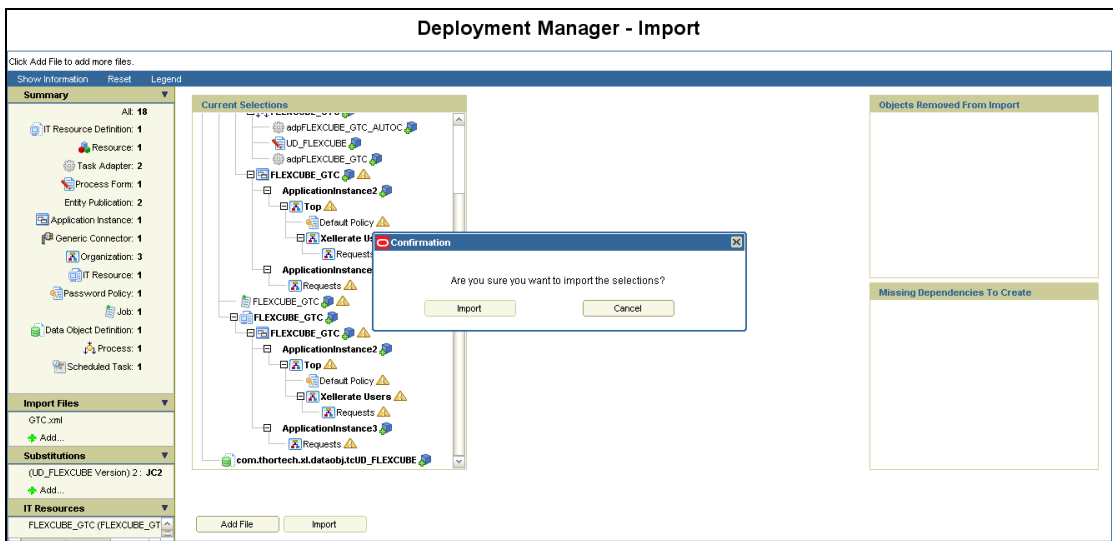

Note: Import of GTC.xml may take more time as compare to other imports.

5.1.6.28 On successful import following screen will come

q. Ensure that import is successful and click on ok.

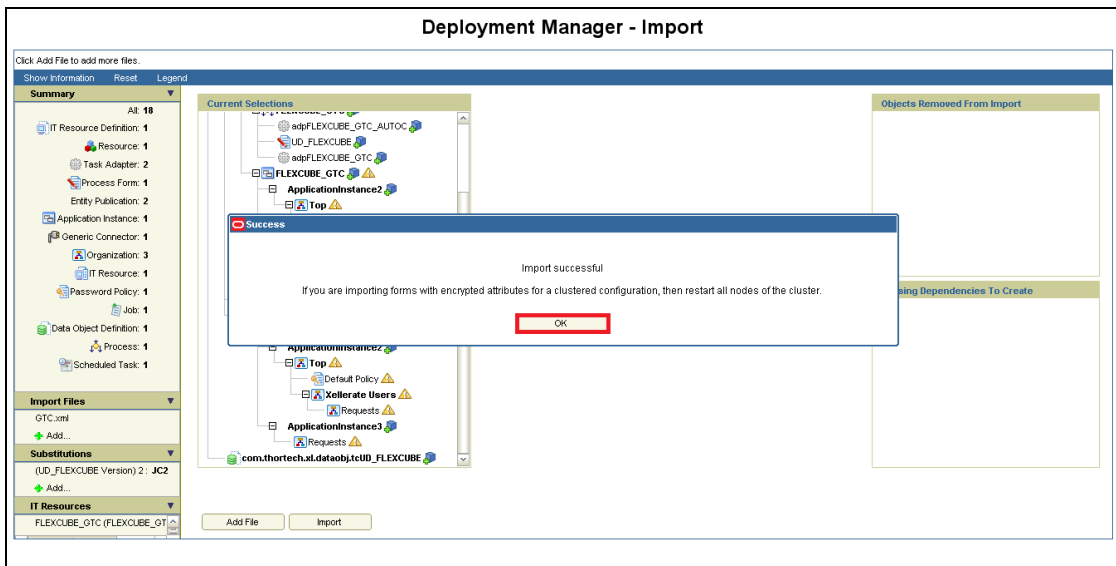

5.1.6.29 Click on Sandboxes



5.1.6.30 Click on Create Sandbox



5.1.6.31 Enter the Below Details and Click on Save and Close

- r. Sandbox Name : Oracle FLEXCUBESANDBOX
- s. Sandbox Description : Oracle FLEXCUBESANDBOX

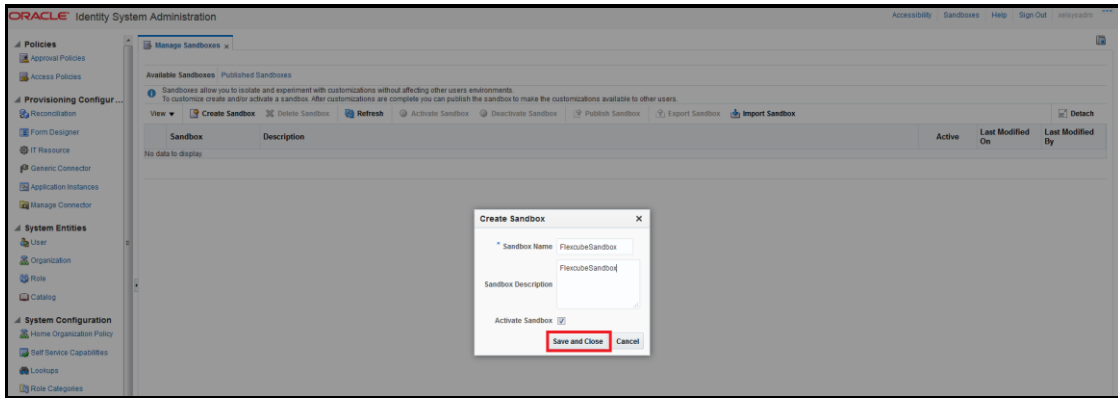

5.1.6.32 Click on Ok

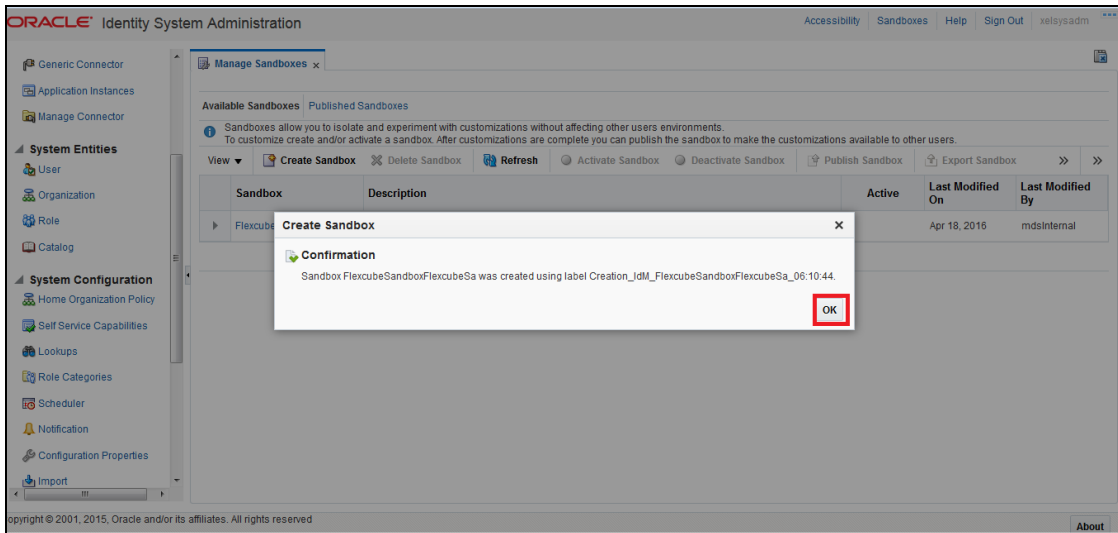

5.1.6.33 Click on Form Designer under Provisioning Configuration

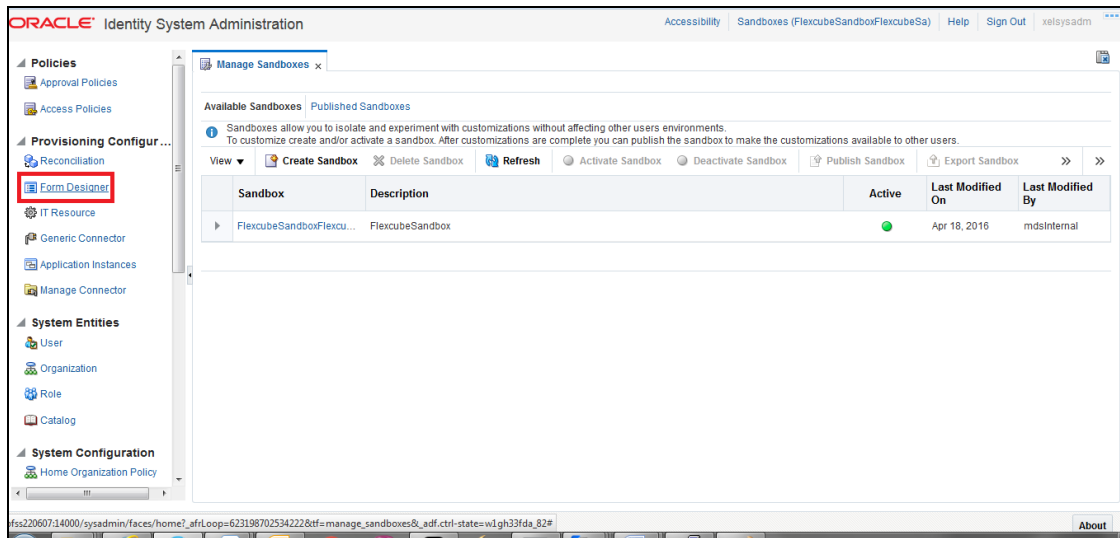

5.1.6.34 Click on Create

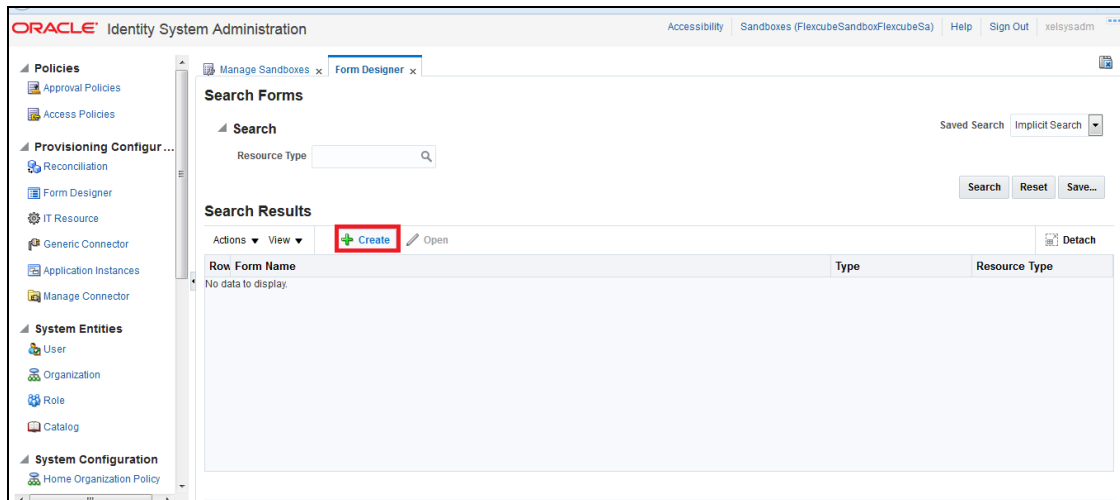

5.1.6.35 Enter the below details and Click on Create

- Resource Type : FLEXCUBE_GTC
- Form Name : FLEXCUBEFORM

Note*: Form Name should be same as above

The screenshot shows the Oracle Identity System Administration interface. The main content area is titled "New form for FLEXCUBE_GTC". It contains two input fields: "Resource Type" with the value "FLEXCUBE_GTC" and "Form Name" with the value "FlexcubeForm". A red box highlights the "Create" button in the top right corner. Below the input fields is a section titled "Available form fields" which includes a table with the following data:

| # | Display Name | Name | Description | Bulk Update |
|---|--------------|-------------------------|-------------|--------------------------|
| 1 | containerID | UD_FLEXCUBE_CONTAINERID | containerID | <input type="checkbox"/> |

5.1.6.36 Successful form creation will be like below:

The screenshot shows the Oracle Identity System Administration interface after successful form creation. A green checkmark and the message "Form created successfully" are visible at the top. The main content area is titled "Search Forms" and includes a search bar with "Resource Type" and a search button. Below the search bar is a "Search Results" section with a table that currently displays "No data to display".

| Row | Form Name | Type | Resource Type |
|---------------------|-----------|------|---------------|
| No data to display. | | | |

5.1.6.37 Click on Application Instances under Provisioning Configuration

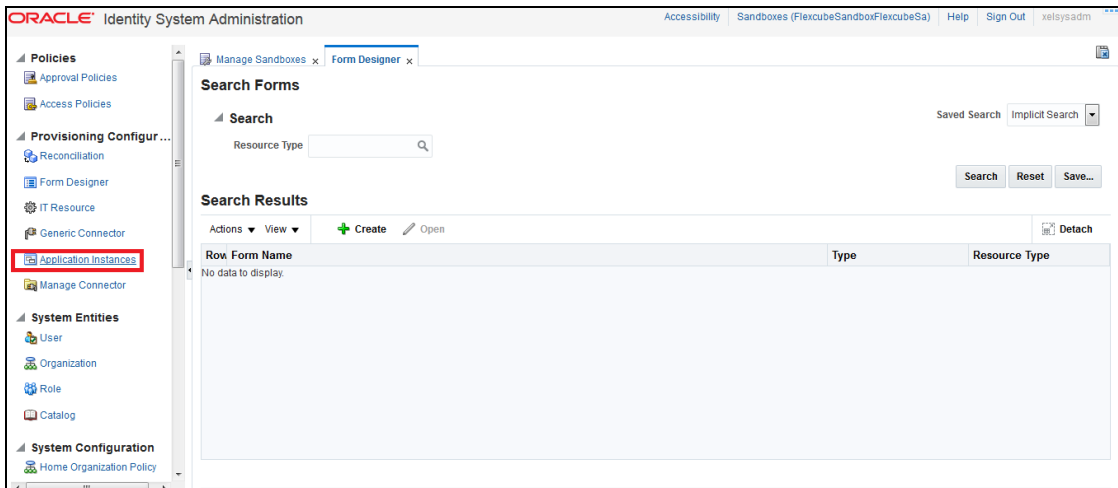

5.1.6.38 Click on Search

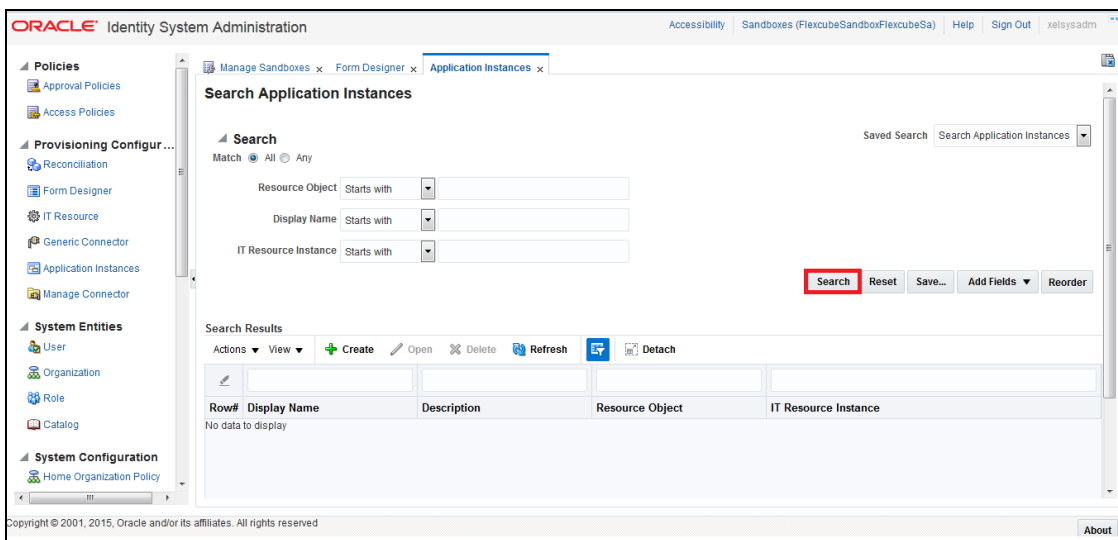

5.1.6.39 Click on FLEXCUBE_GTC

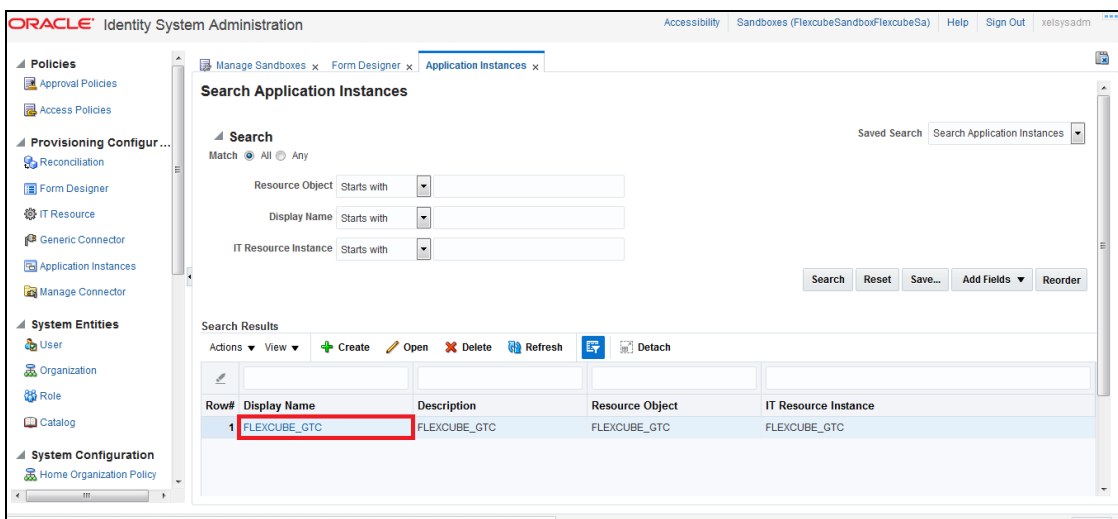

5.1.6.40 Choose the Form as FlexcubeForm and Click on Apply

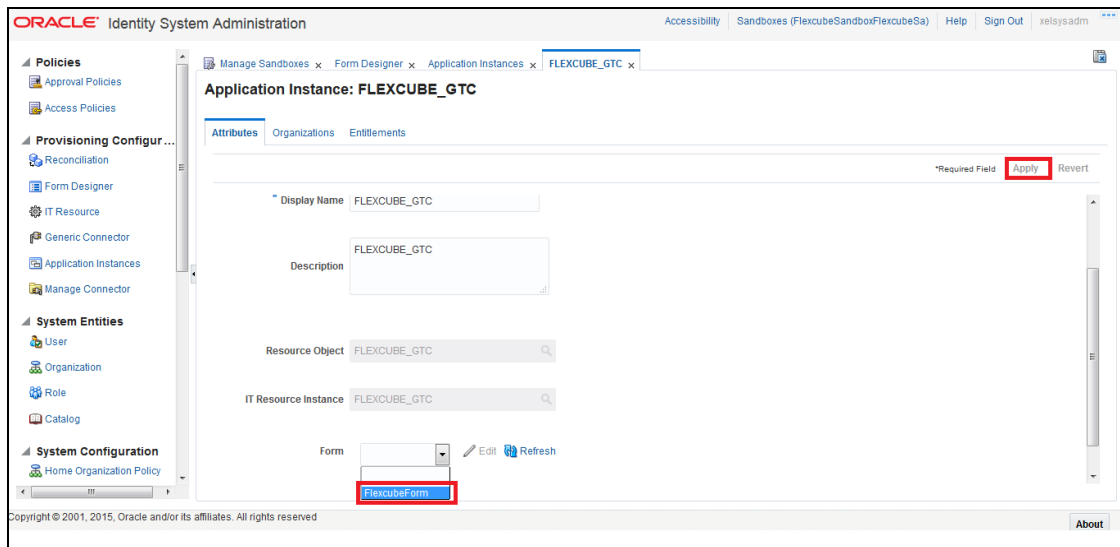

5.1.6.41 On Successful modification will be shown like below:

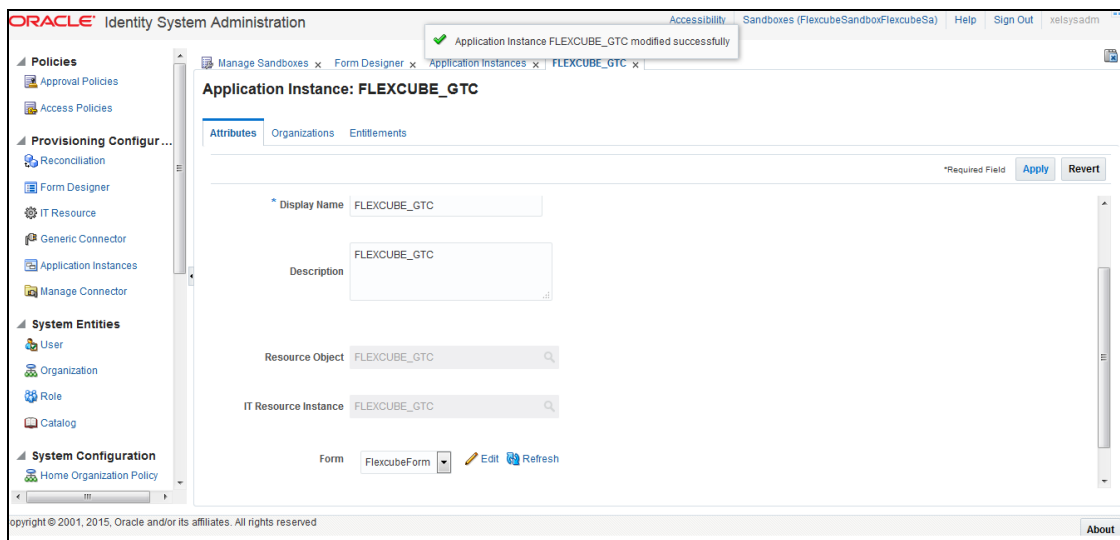

Application Instance belongs to the following Organizations

Note: In case provisioning has to be applied for different Organizations then Create the Organizations under System Entities and map those Organizations to the Application Instance.

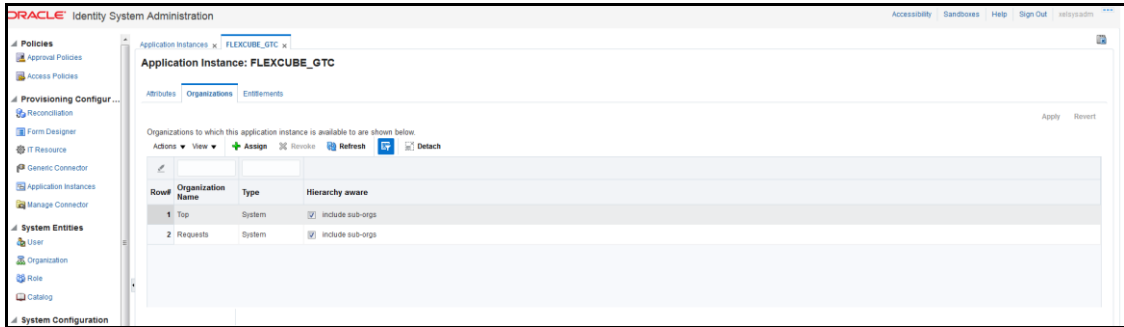

5.1.6.42 Select and click on Publish Sandbox

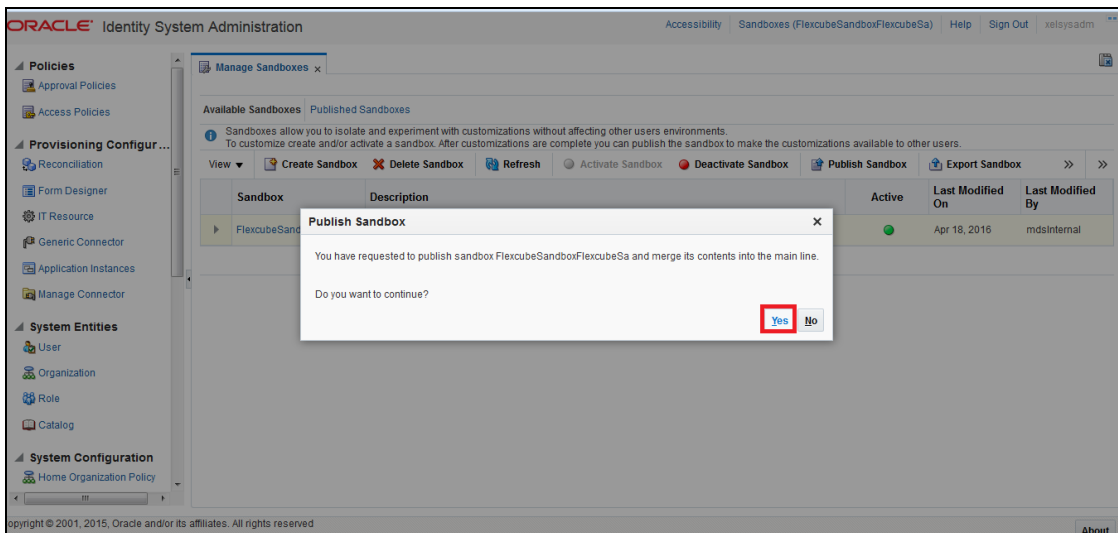
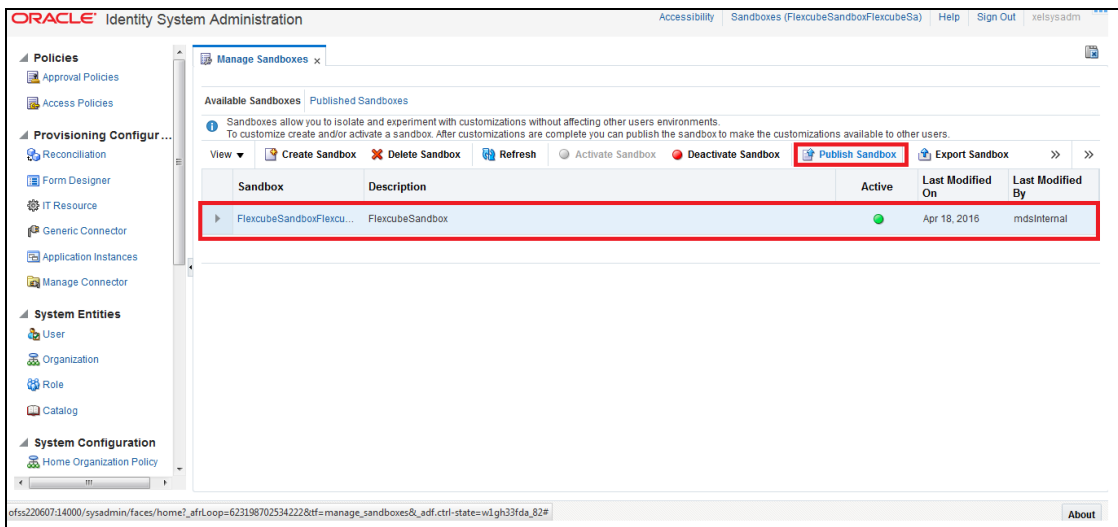

5.1.6.43 Click on Scheduler under System Configuration

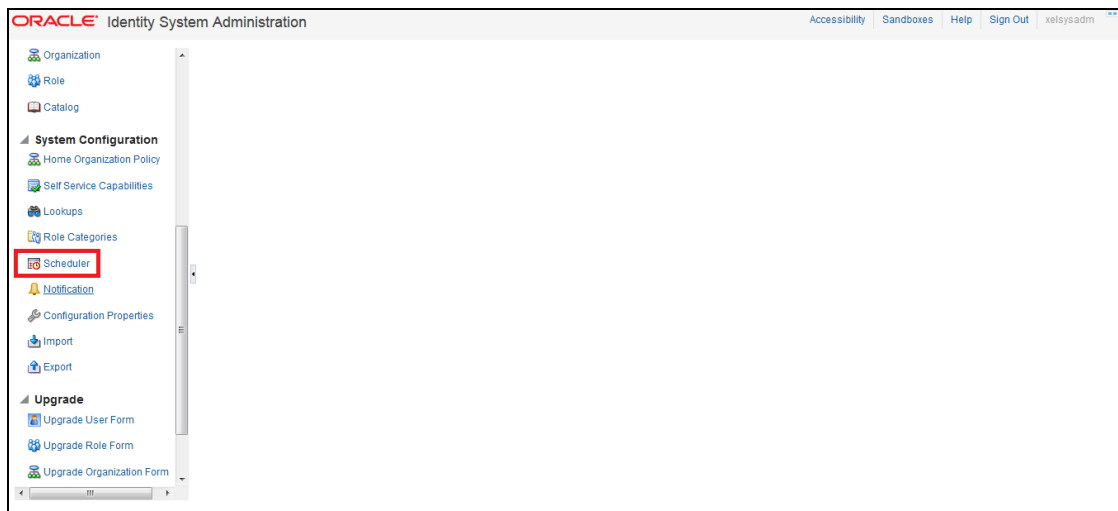

5.1.6.44 Click on to Search for Scheduled Job List

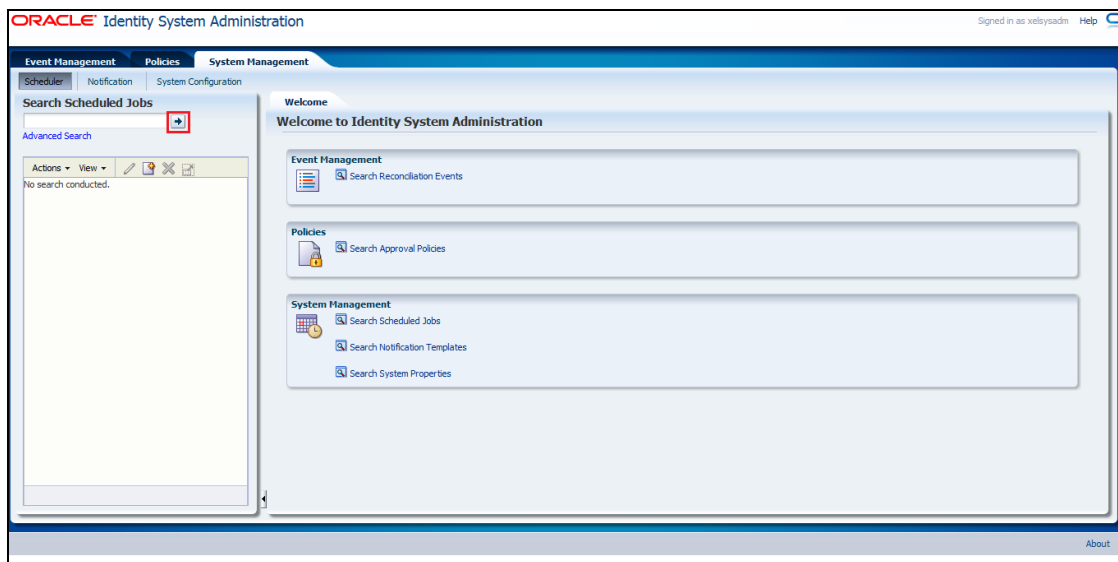

5.1.6.45 Click on Entitlement List

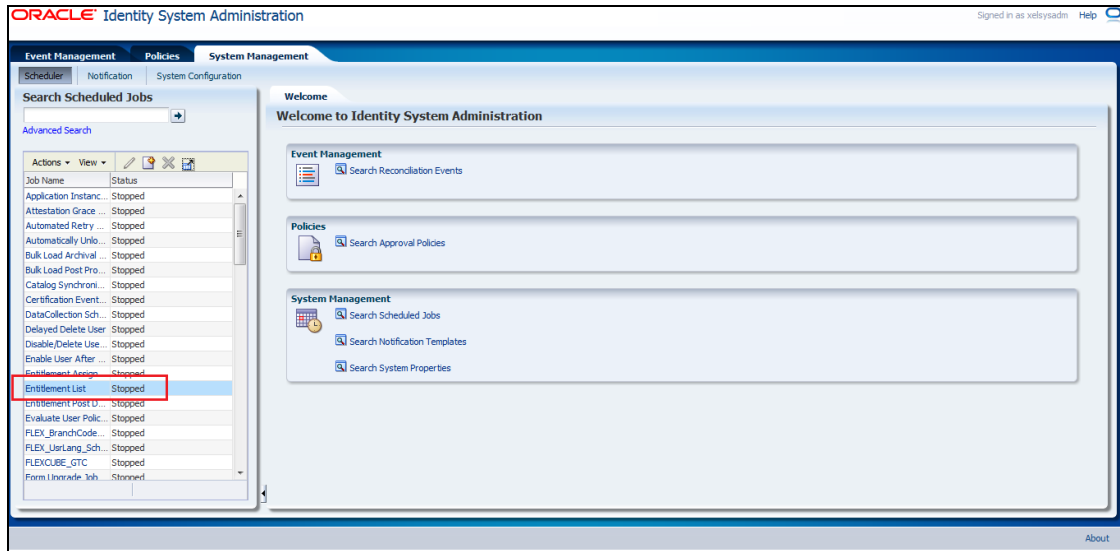

5.1.6.46 Click on Run Now

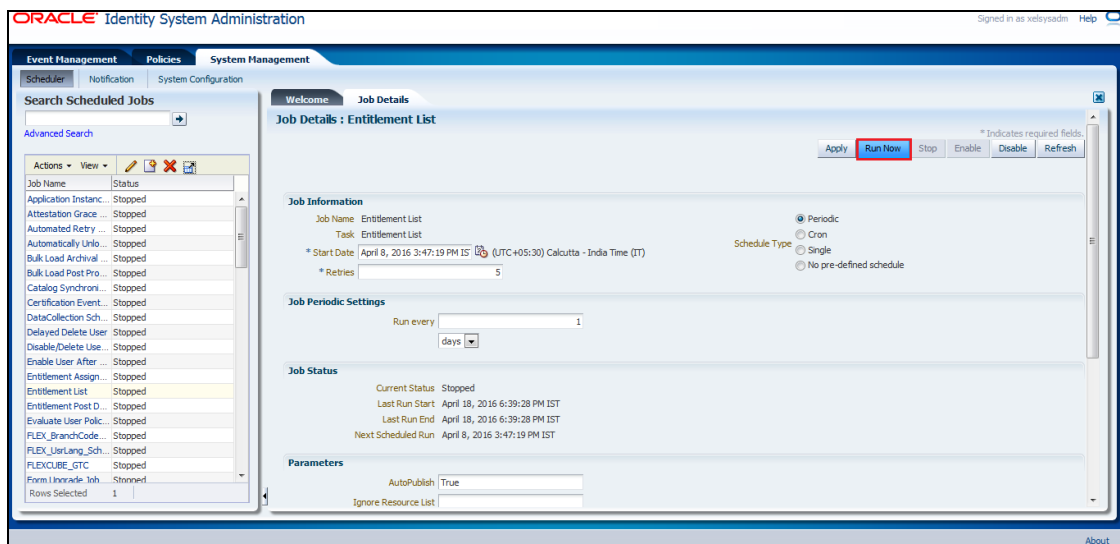

5.1.6.47 Schedule Task Setup

This step involves setting up Schedule task parameters.

5.1.6.47.1 **Open the Oracle Identity Manager Administrative console. (Give the following URL in the browser: `http://<hostname>:<oimport>/sysadmin`)**

5.1.6.47.2 **Enter OIM administrator username/password and press Login**

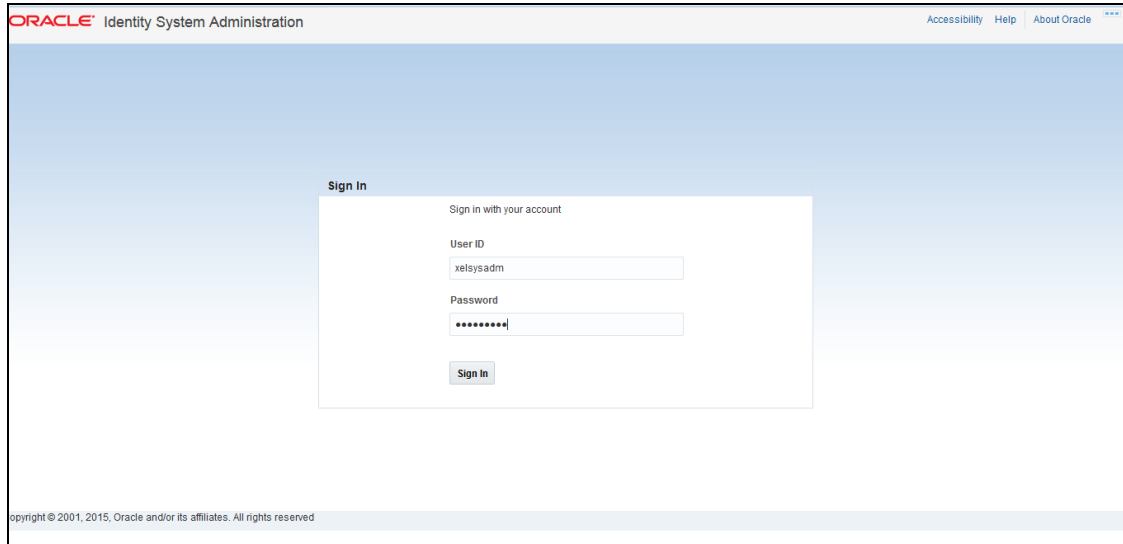

The screenshot shows the Oracle Identity System Administration Sign In page. The page title is "ORACLE Identity System Administration" and it includes links for "Accessibility", "Help", and "About Oracle". The main content area is titled "Sign In" and contains the text "Sign in with your account". Below this, there are two input fields: "User ID" with the value "xelsysadm" and "Password" with masked characters "*****". A "Sign In" button is located below the password field. At the bottom of the page, there is a copyright notice: "copyright © 2001, 2015, Oracle and/or its affiliates. All rights reserved."

5.1.6.47.3 **Click on Scheduler under System Configuration**



5.1.6.47.4 Click on  to Search for Scheduled Job List

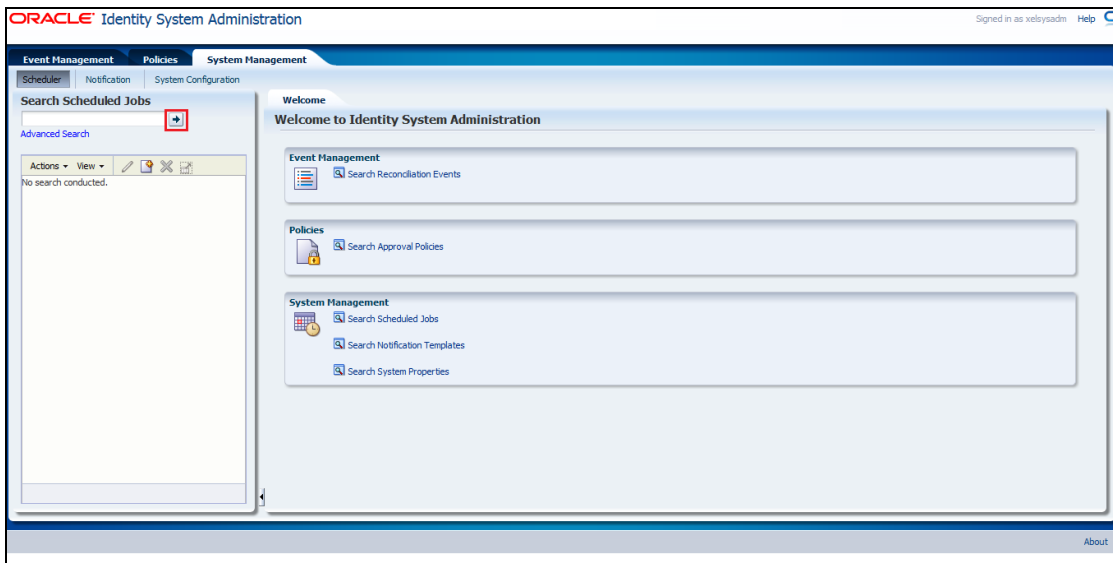

5.1.6.47.5 Click on FLEX_BranchCode_SchTask

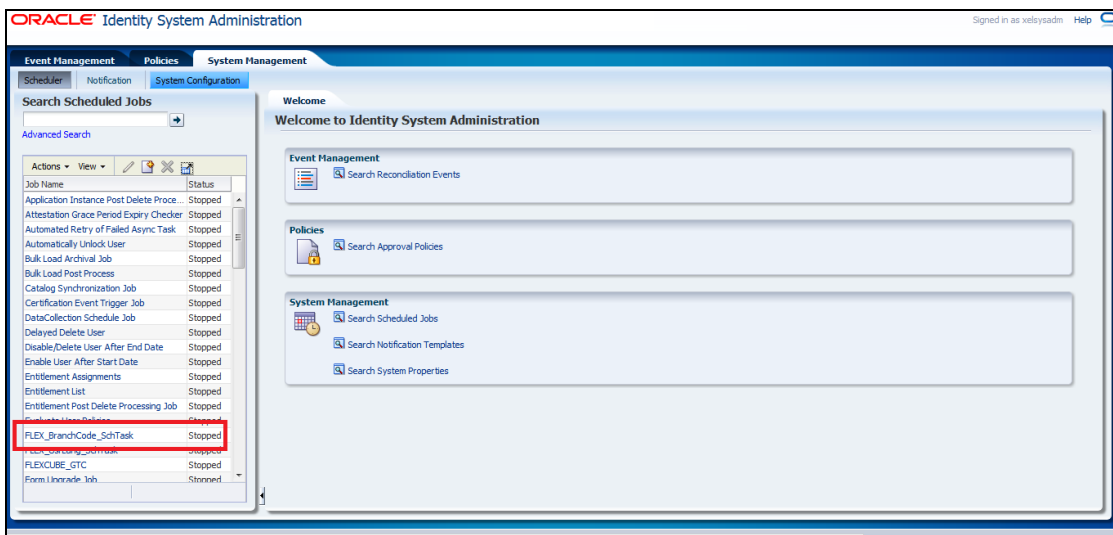

5.1.6.47.6 On the Edit Schedule Task screen

- WebService Url : FCUBSLOVAdService deployed in section [5.1.4.2.1](#)
 https://<hostname>:<ssl_port>/FCUBSLOVAdService/FCUBSLOVAdServiceSEI
- Query :
 FCUBS :
 select branch_code||'~'||branch_code from sttm_branch order by branch_code
 FCIS :
 select moduleid||'~'||moduleid from moduleprofilebasetbl where once_auth='Y' order by moduleid

- Click on Apply and Click on Run.

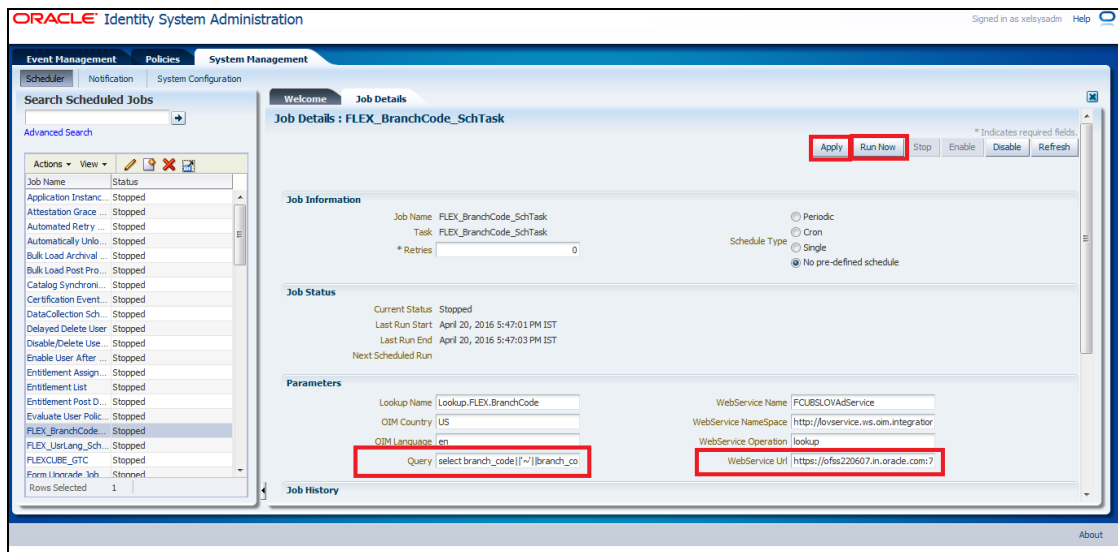

5.1.6.47.7 Modify FLEX_UsrLang_SchTask job

- WebService Url : FCUBSLOVAdService deployed in section 5.1.4.2.1
https://<hostname>:<ssl_port>/FCUBSLOVAdService/FCUBSLOVAdServiceSEI
- Click on Apply and Click on Run.

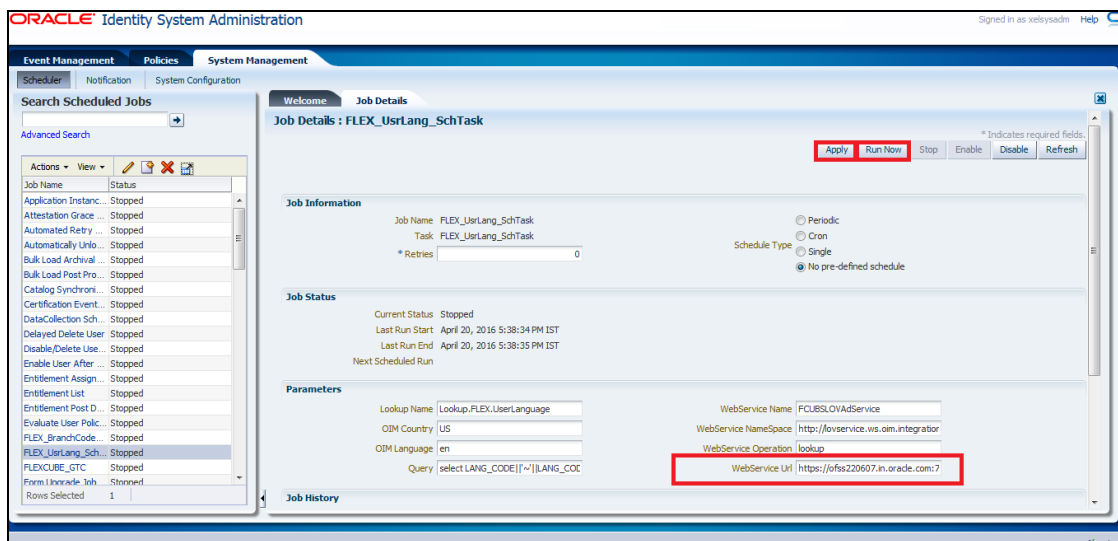

5.1.7 System Configurations

5.1.7.1 Integration Specific Configurations

5.1.7.1.1 FCIS Configurations

On FCIS side following configurations need to be done:

- Maintenance of Maker ID
- Maintenance of External Source

Both configurations can be done using FCJ provided screens.

1. Maintenance of Maker ID

The FCJ screen can be open through Security Maintenance >> Users >> Detailed menu or using the function SMDUSRDF.

2. Maintenance of External Source

For OIM request and response handling, an external source should be maintained in FCIS database.

The FCJ screen can be open through Gateway >> External System >> Detailed menu or using the function 'GWDEXSYS'.

| | | | | |
|--|--------|-------|------|--|
| This external source should be able to do all operations like Create | Modify | Close | Open | View. This can be maintained through function GWDEXFUN or through Gateway >> External System Functions >> Detailed. Required actions and their corresponding details are given as below. |
|--|--------|-------|------|--|

| Action | Function | Service Name | Operation Code |
|--------|----------|---------------|-----------------|
| NEW | SMGUSRDF | FCISSMService | CreateUserMaint |
| UNLOCK | SMGUSRDF | FCISSMService | ModifyUserMaint |
| DELETE | SMGUSRDF | FCISSMService | DeleteUserMaint |
| CLOSE | SMGUSRDF | FCISSMService | CloseUserMaint |
| REOPEN | SMGUSRDF | FCISSMService | ReopenUserMaint |
| VIEW | SMQUSRDF | FCISSMService | QueryUserMaint |

Ensure that required maintenance has been done for function CODSORCE (Gateway >> Source>>

Detailed) and for function CODUPLDM (Gateway >> Source Preferences >> Detailed menu)

For maintenance of amendable fields in GWTM_AMEND_NODES and GWTM_AMEND_FIELDS entries can be made using the function STDAMDMT or through Gateway >> Amendment Maintenance >> Detailed. Following table gives the amendable node and fields details that should be maintained.

| Field Name | Value |
|----------------------|---------------|
| Amend Nodes section | |
| Node Name | SMTB_USER |
| New Allowed | Checked |
| Delete Allowed | Checked |
| All Records | Checked |
| Amend Fields section | |
| Field Name | HOME_BRANCH |
| Field Name | START_DATE |
| Field Name | TIME_LEVEL |
| Field Name | USER_LANGUAGE |
| Field Name | USER_NAME |
| Field Name | USER_PASSWORD |
| Field Name | SALT |

5.1.7.2 OIM Configurations

5.1.7.2.1 OID Connector Configuration

For Oracle FLEXCUBE single sign on mode, the provisioning process consist of user creation in underlying LDAP directory and then provsioining into FLEXCUBE. OIM porvides out of box connectors for LDAP directories. This connectors provides facility to connect with LDAP and to do the operation through OIM console.

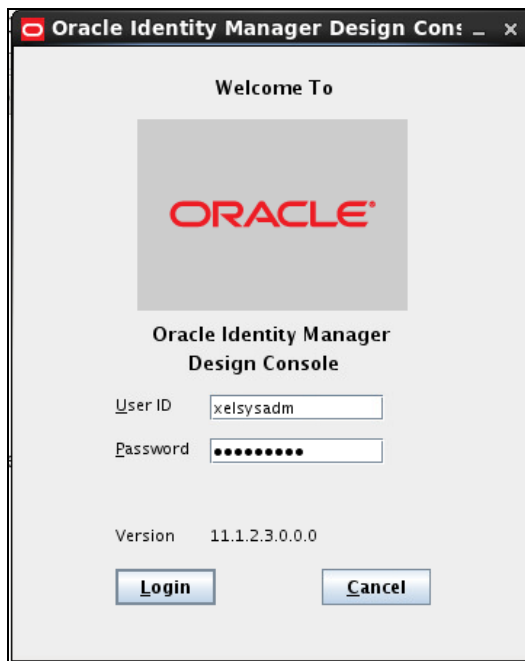

In this integration, the underlying directory for Oracle access manager is Oracle Internet Directory. OIM porvides out of box connector for it that need to be imported as the connector document provided by OIM. After import, following steps should be followed :

5.1.7.2.1.1 Login to the Design Console



5.1.7.2.1.2 Navigate to the Administration>>Lookup Definition menu

a. Enter the below details:

- Code: Lookup.OID.Organization
- Click on **Search**  Icon
- Click on **Add**  button
- Enter the below details:
- Code Key : cn=Users,dc=in,dc=oracle,dc=com
- Decode : cn=Users,dc=in,dc=oracle,dc=com

b. Click on Save 

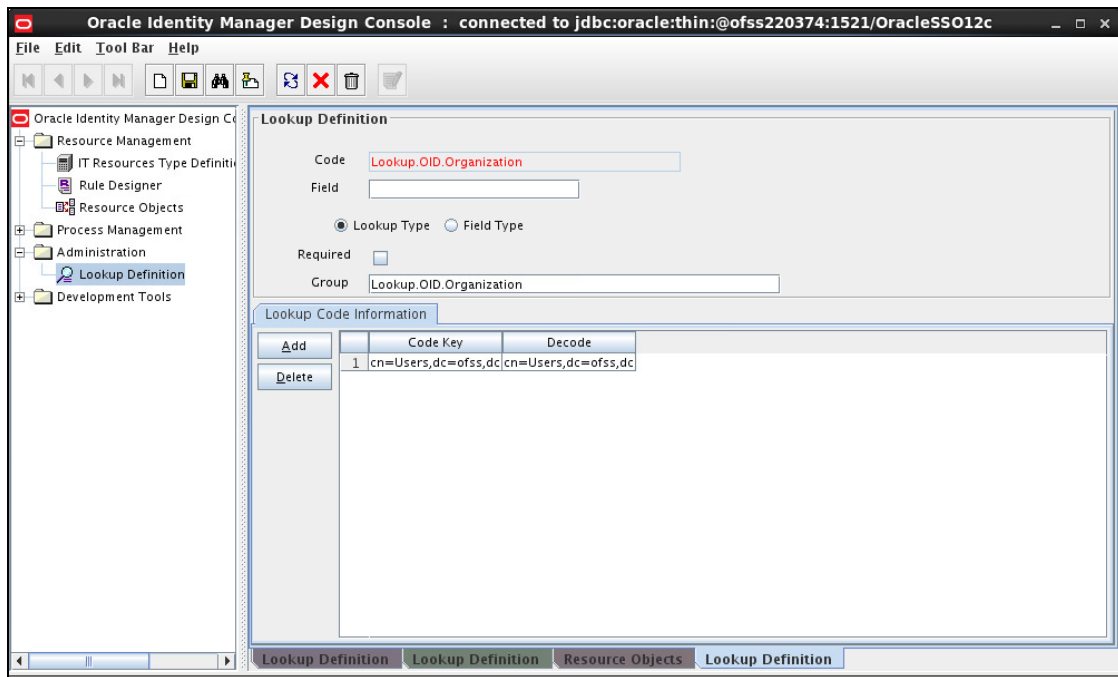

5.1.7.2.1.3 Navigate to the Administration>>Lookup Definition menu

a. Enter the below details:

- Code:
- Click on Search  Icon
- Modify the Decode value for Code Key Name:
- From :
- To :

b. Click on Save .

- 5.1.7.2.1.4 Navigate to the Resource Management>>Resource Objects menu. This will open a blank screen.
- Enter FLEXCUBE_GTC in Name box.
 - Click on Search icon.
 - This will show the definition for resource FLEXCUBE_GTC. Click on Assign button in Depends On tab.

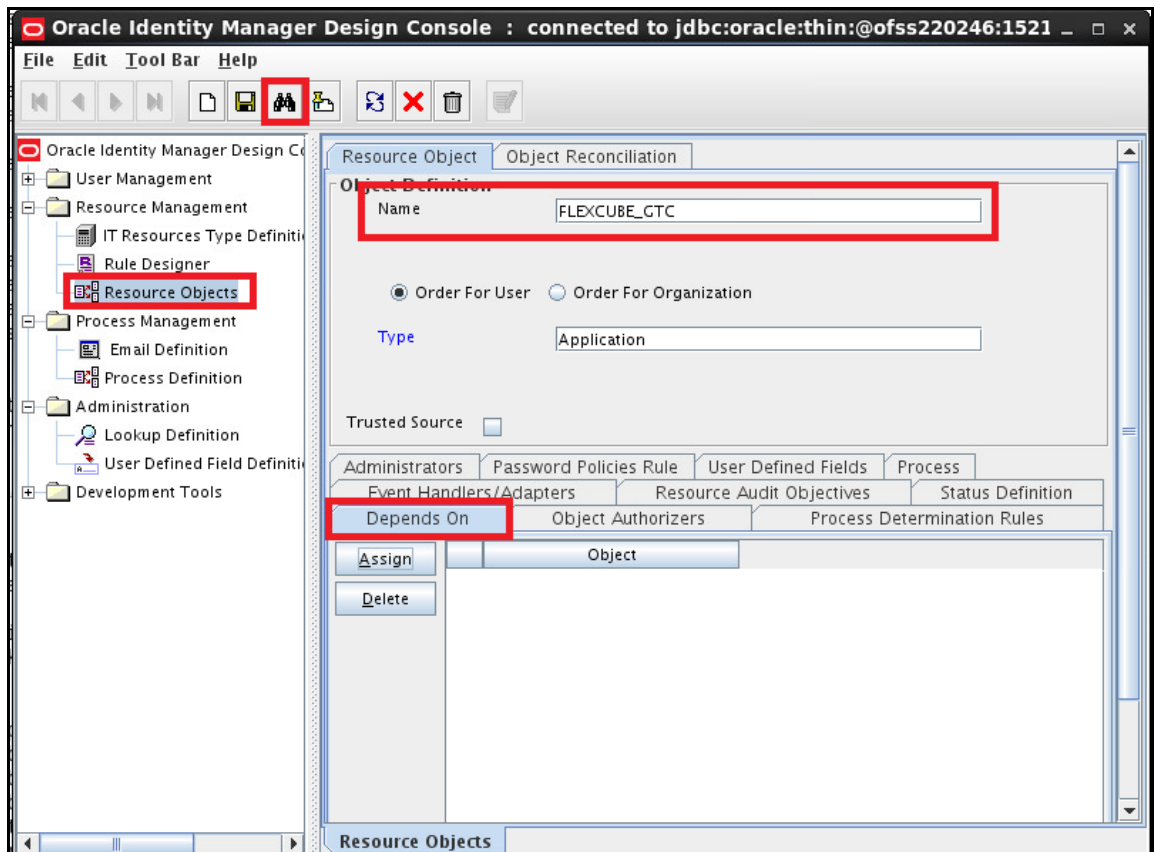

5.1.7.2.1.5 Select the OID User from the Unassigned Objects list. Click on the arrow pointed to Assigned objects.

a. Click on OK. This will move OID user resource to Assigned objects.

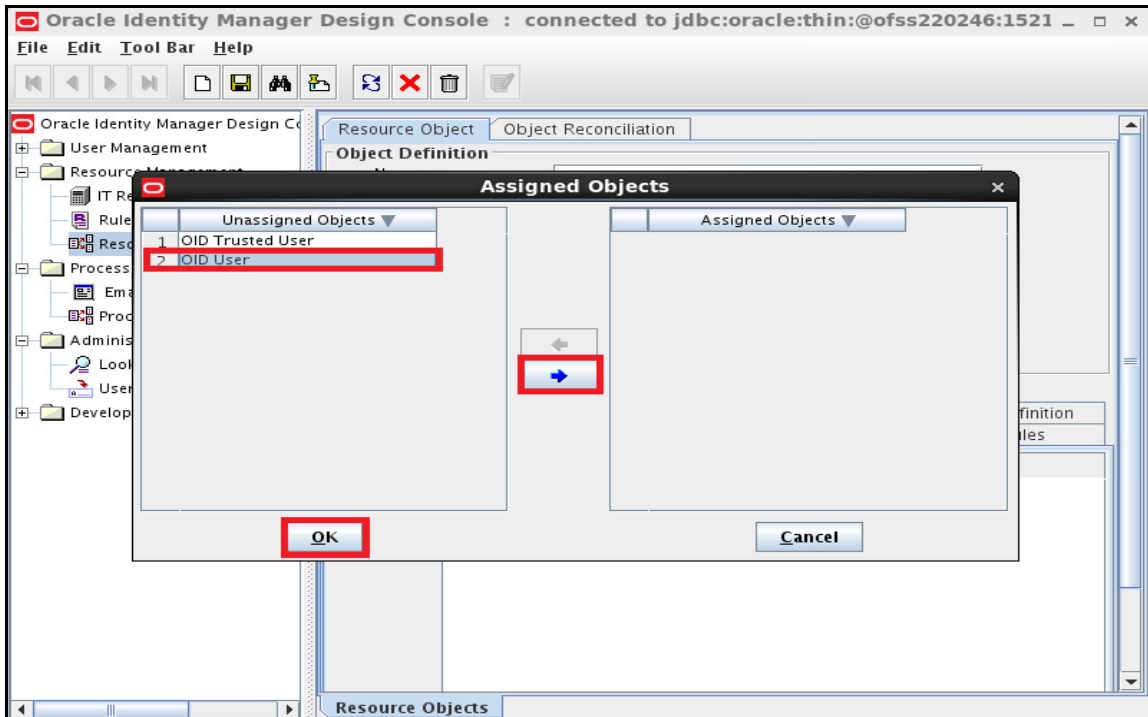

5.1.7.2.1.6 Ensure that OID User will be shown under Object.

a. Click on Save.

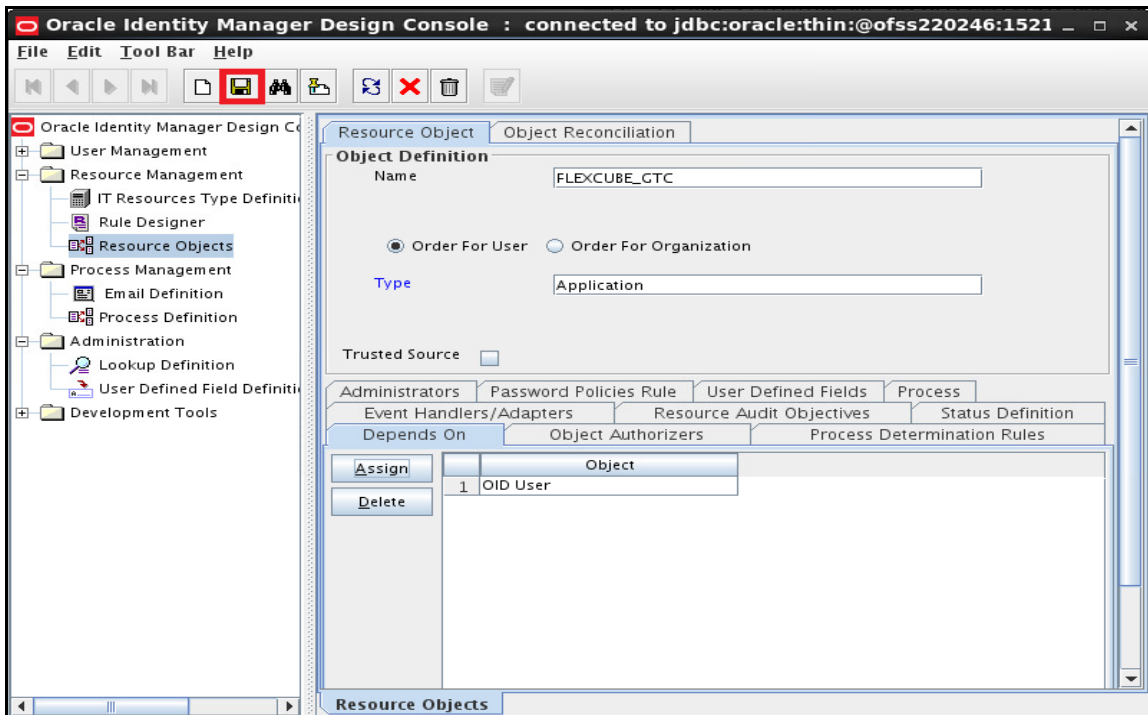

5.1.7.2.2 Access Policy Creation for OID

5.1.7.2.2.1 Open the Oracle Identity Manager Administrative console. (Give the following URL in the browser: `http://<hostname>:<oimport>/sysadmin`)

5.1.7.2.2.2 Login to Administrative Console

- a. Enter OIM administrator username/password and press Sign In.

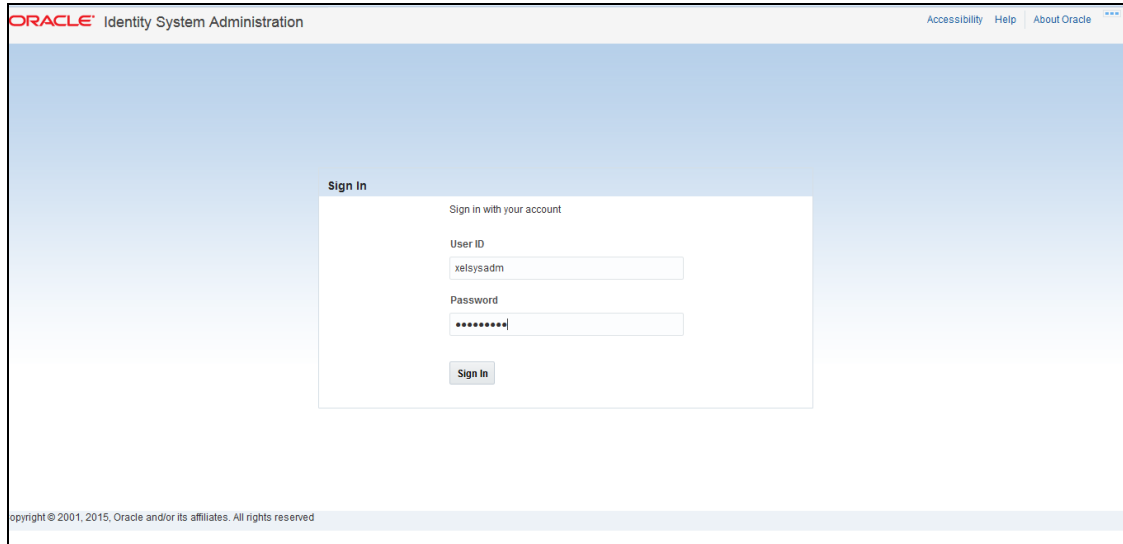

The screenshot shows the Oracle Identity System Administration web interface. At the top, the title is "ORACLE Identity System Administration" with links for "Accessibility", "Help", and "About Oracle". The main content area is a "Sign In" form with the heading "Sign in with your account". It contains two input fields: "User ID" with the value "xelsysadm" and "Password" with masked characters "*****". A "Sign In" button is located below the password field. At the bottom left, there is a copyright notice: "Copyright © 2001, 2015, Oracle and/or its affiliates. All rights reserved."

5.1.7.2.2.3 Click on Access Policies under Policies

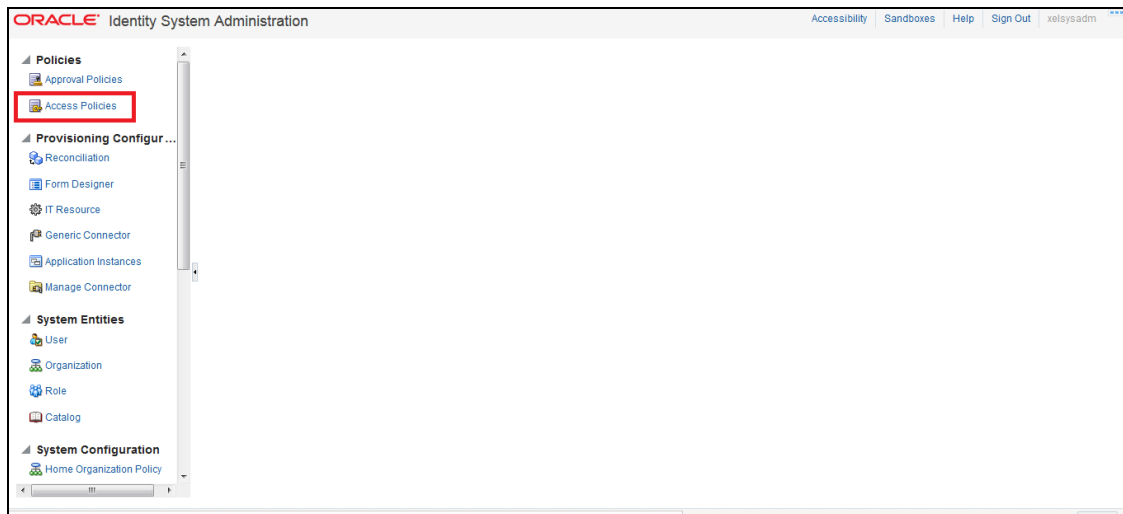

5.1.7.2.2.4 Click on Create Access Policy

Manage Access Policies
Enter your search criteria to search for access policies.

5.1.7.2.2.5 Enter the below details and Click on Continue

- Access Policy Name : OIDAccessPolicy
- Access Policy Description : OIDAccessPolicy
- Policy Owner : Role in Dropdown and ALL USERS from LOV.
- Retrofit Access Policy : Yes
- Priority : 1

Create Access Policy

1 2 3 4

Step 1: Create Access Policy

* Indicates Required Field

Access Policy Name *

Access Policy Description *

Policy Owner

Retrofit Access Policy

Priority * Current Lowest Priority=1

5.1.7.2.2.6 Perform the below mentioned Operations and Click on Continue

- Select OID User
- Click on Add Button

Create Access Policy

1 2 3 4

Step 2: Select Resources

Specify the resources to be provisioned by this access policy.

* Indicates Required Field

Filter By: [] [] Go

Results 1-2 of 2 First | Previous | Next | Last

| <input type="checkbox"/> | Resource Name | |
|-------------------------------------|---------------|--|
| <input type="checkbox"/> | FLEXCLUBE_GTC | |
| <input checked="" type="checkbox"/> | OID User | |

First | Previous | Next | Last

Selected:

Exit << Back **Continue >>**

5.1.7.2.2.7 Click on Continue

Create Access Policy

1 2 3 4

Step 2: Select Resources

The subsequent pages will guide you through providing the data to associate with the following resources you selected to be provisioned by this Access Policy:

- OID User

Exit << Back Skip This Step **Continue >>**

5.1.7.2.2.8 Select the below Details and Click on Continue

- Server : OID Server
- Container DN : cn=Users,dc=in,dc=oracle,dc=com
- Preferred Language : English
- Start Date : April 20, 2016 (Current Date)
- End Date : April 20, 2026 (End Date)

Provide the following process details for resource **OID User**:

* Indicates a required field

| | | | |
|--------------------|---|---------------------------|-----------------------|
| User ID | * | <input type="text"/> | |
| Server | * | OID Server | Clear |
| Password | | <input type="text"/> | |
| First Name | | <input type="text"/> | |
| Middle Name | | <input type="text"/> | |
| Last Name | * | <input type="text"/> | |
| Common Name | * | <input type="text"/> | |
| Container DN | * | cn=Users,dc=ofss,dc=in,dc | Clear |
| Department | | <input type="text"/> | |
| Location | | <input type="text"/> | |
| Telephone | | <input type="text"/> | |
| Email ID | | <input type="text"/> | |
| Preferred Language | | English | Clear |
| Time Zone | | <input type="text"/> | |
| Title | | <input type="text"/> | |
| Start Date | | April 20, 2016 | <input type="text"/> |
| End Date | | April 20, 2026 | <input type="text"/> |
| manager | | <input type="text"/> | |

[Exit](#) [<< Back](#) [Set Additional Data](#) [Continue >>](#)

5.1.7.2.2.9 Click on Continue

Create Access Policy

1 2 3 4

Step 2: Select Revoke Or Disable Flag

Select if the resources need to be revoked or disabled if the access policy no longer applies.

| Resource Name | Revoke if no longer applies | Disable if no longer applies |
|---------------|----------------------------------|------------------------------|
| OID User | <input checked="" type="radio"/> | <input type="radio"/> |

[Exit](#) [<< Back](#) [Continue >>](#)

5.1.7.2.2.10 Click on Continue

Create Access Policy 1 2 3 4

Step 3: Select Resources

Specify the resources to be denied by this access policy.

* Indicates Required Field

Filter By

Results 1-2 of 2 First | Previous | Next | Last

| <input type="checkbox"/> | Resource Name | |
|--------------------------|---------------|--|
| <input type="checkbox"/> | FLEXCUBE_GTC | <input type="button" value="Add >>"/> |
| <input type="checkbox"/> | OID User | <input type="button" value="Remove <<"/> |

First | Previous | Next | Last

5.1.7.2.2.11 Click on Create Access Policy

Access Policy Name OIDAccessPolicy
Access Policy Description OIDAccessPolicy
Policy Owner Type Role
Policy Owner SYSTEM ADMINISTRATORS
Retrofit Access Policy Yes
Priority 1

Resources to be provisioned by this access policy [Change](#)

| Resource Name | Revoke if no longer applies | Disable if no longer applies | Process Forms |
|---------------|-------------------------------------|------------------------------|-------------------------------|
| OID User | <input checked="" type="checkbox"/> | <input type="checkbox"/> | OID User Edit |

Resources to be denied by this access policy [Change](#)

You have not selected any resources to be denied by this access policy.

Roles for this access policy

Roles Name

5.1.7.2.2.12 Login to Identity Self Services

<http://<hostname>:<oimport>/oim/console> or <http://<hostname>:<oimport>/identity>

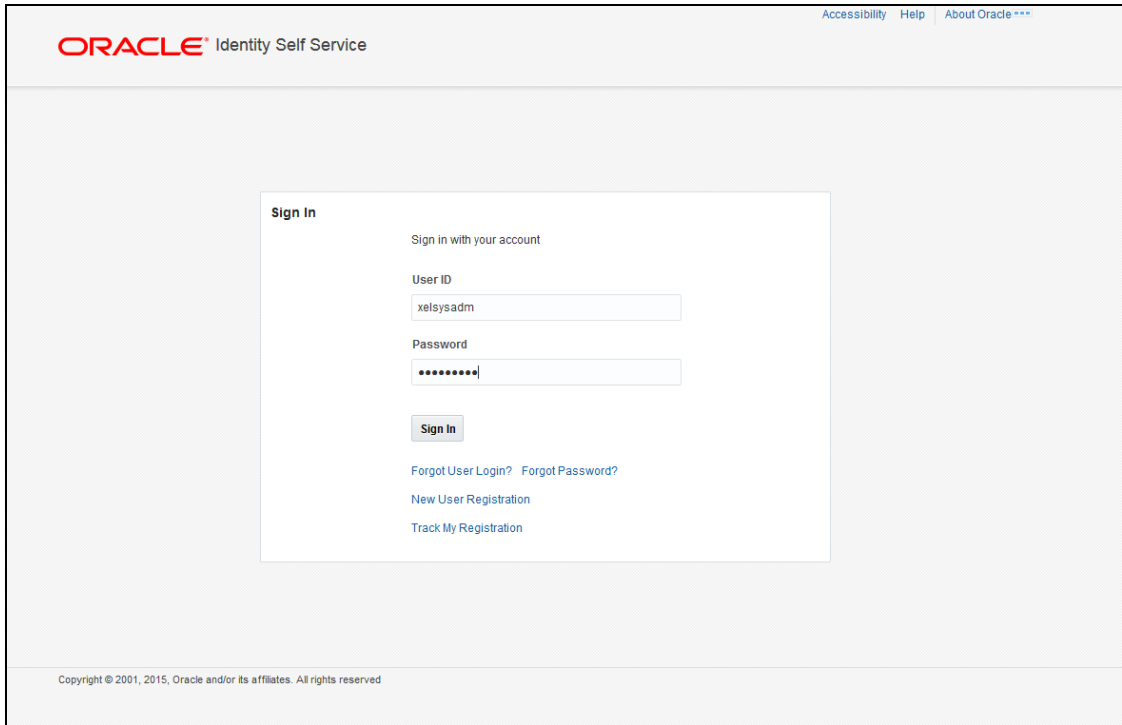

5.1.7.2.2.13 Click on Roles under Manage

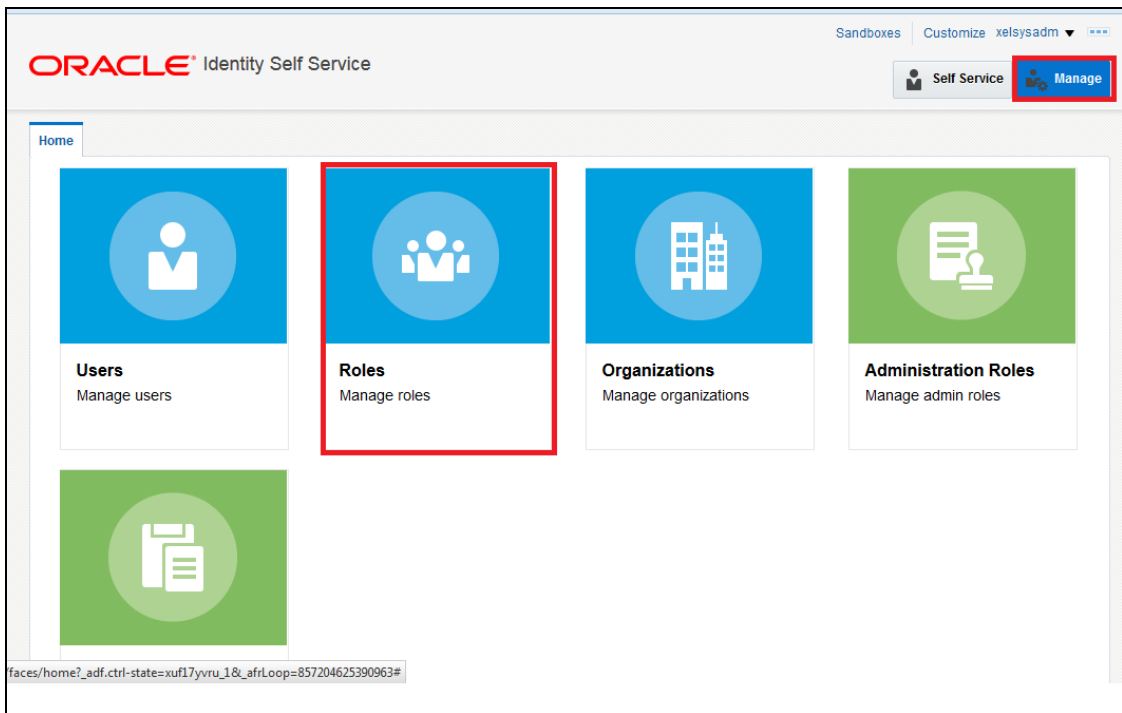

5.1.7.2.2.14 Select ALL USERS to Edit

The screenshot shows the Oracle Identity Self Service interface. At the top, there is a header with the Oracle logo and 'Identity Self Service'. On the right, there are links for 'Sandboxes', 'Customize', and 'xelsysadm'. Below the header, there are tabs for 'Home' and 'Roles x'. The main content area is titled 'Roles' and contains a search bar with 'Name' selected. Below the search bar, there are action buttons: 'Create', 'Open', 'Delete', 'Refresh', and 'Detach'. A table lists several roles, with 'ALL USERS' highlighted by a red box. The table has two columns: 'Name' and 'Role Description'. The 'ALL USERS' role has the description 'Default role for all users'.

| Name | Role Description |
|-----------------------|--|
| ALL USERS | Default role for all users |
| Administrators | Administrators role for SOA |
| BIReportAdministrator | Administrators role for BI Publisher Reports |
| OPERATORS | Operator role |
| SELF OPERATORS | Operator role for self registration |
| SYSTEM ADMINISTRATORS | System Administrator role for OIM |

5.1.7.2.2.15 Click on Access Policy

The screenshot shows the Oracle Identity Self Service interface for the 'ALL USERS' role. The breadcrumb navigation shows 'Home', 'Roles x', and 'ALL USERS x'. The main content area is titled 'ALL USERS' and has tabs for 'Attributes', 'Hierarchy', 'Access Policy', 'Members', and 'Organizations'. The 'Access Policy' tab is highlighted with a red box. Below the tabs, there are several fields: 'Name' (ALL USERS), 'Role Namespace' (Default), 'Display Name' (ALL USERS), 'Role E-mail' (empty), 'Role Description' (Default role for all users), and 'Owned By' (System Administrator).

5.1.7.2.2.16 Click on + Add to Add Access Policy

The screenshot shows the Oracle Identity Self Service interface for the 'ALL USERS' role. The breadcrumb navigation shows 'Home', 'Roles x', and 'ALL USERS x'. The main content area is titled 'ALL USERS' and has tabs for 'Attributes', 'Hierarchy', 'Access Policy', 'Members', and 'Organizations'. The 'Access Policy' tab is selected. Below the tabs, there is a message: 'Add access policies to define access rights of this role.' Below the message, there are action buttons: 'Add', 'Remove', 'Undo', 'Refresh', and 'Detach'. The 'Add' button is highlighted with a red box. Below the buttons, there is a table with columns: 'Policy Name', 'Policy Description', and 'Pending Action'. The table is currently empty, with the text 'No data to display' below it.

5.1.7.2.2.17 Search for the Access Policy and Select the Access Policy Created

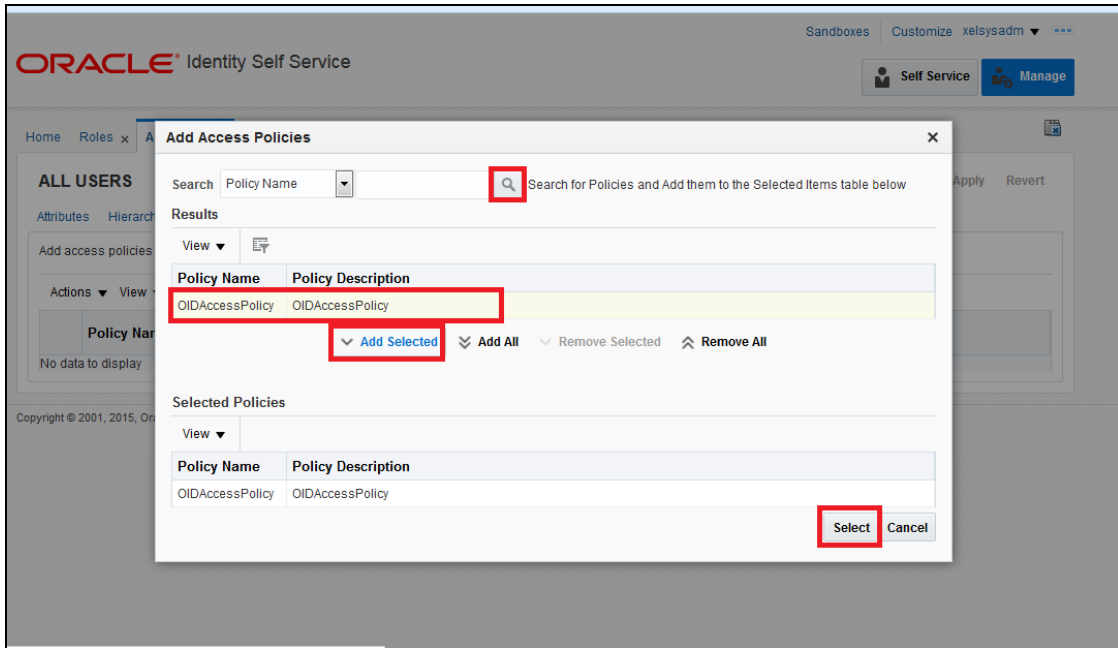

5.1.7.2.2.18 Click on Apply to Save

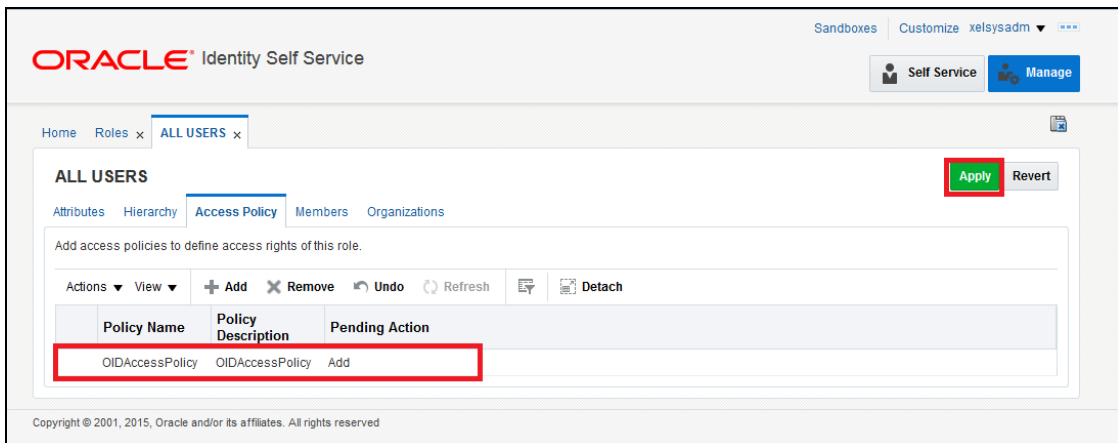

5.1.7.2.2.19 Click on Scheduler under System Configuration



5.1.7.2.2.20 Click on Search shown below

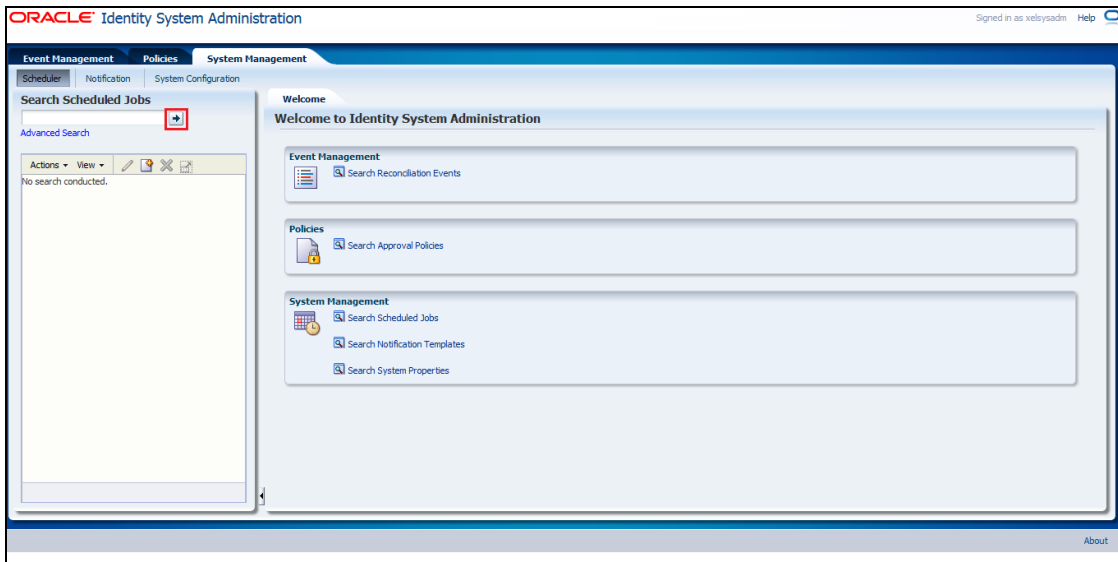

5.1.7.2.2.21 Select Evaluate User Policies

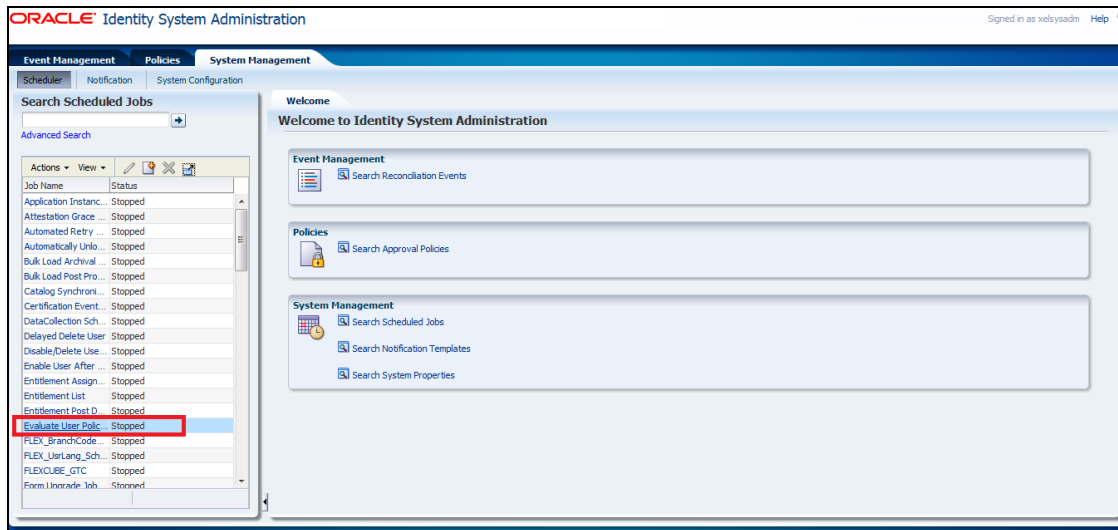

3. Change the Schedule Type under Job Information, also change Run Every under Job Periodic Setting.

a. Click on Apply.

Job will be scheduled in a periodic manner and it will evaluate the New User Created in Oracle Identity Management Server against the access policies created. If the new user satisfied by the access policy then it will Provision the user to User Account. In this case it's Oracle Internet Directory.

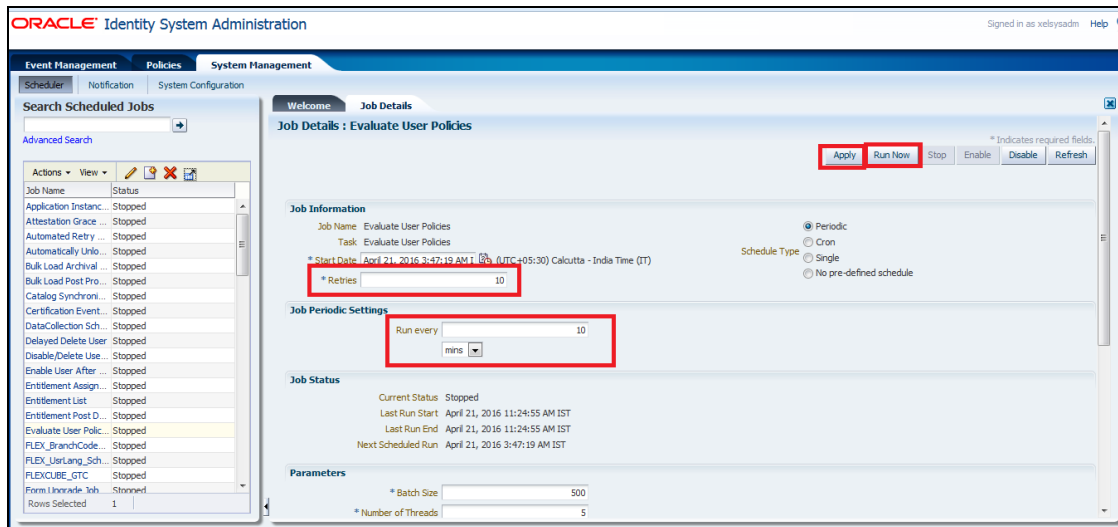

6. Solution / Usage Guidelines

6.1 Working with OIM

6.1.1 Creating a user in Oracle FLEXCUBE through OIM

To create a user in Oracle FLEXCUBE through OIM, first a user must be created in OIM itself. After creating a user in OIM, a user can be created in Oracle FLEXCUBE by assigning a resource named FLEXCUBE_GTC.

Open the Oracle Identity Manager Administrative console. (Give the following URL in the browser: <http://<hostName>:<oimport>/identity>)

6.1.1.1 Login to Administrative Console

- a. Enter OIM administrator username/password and press **Login**.

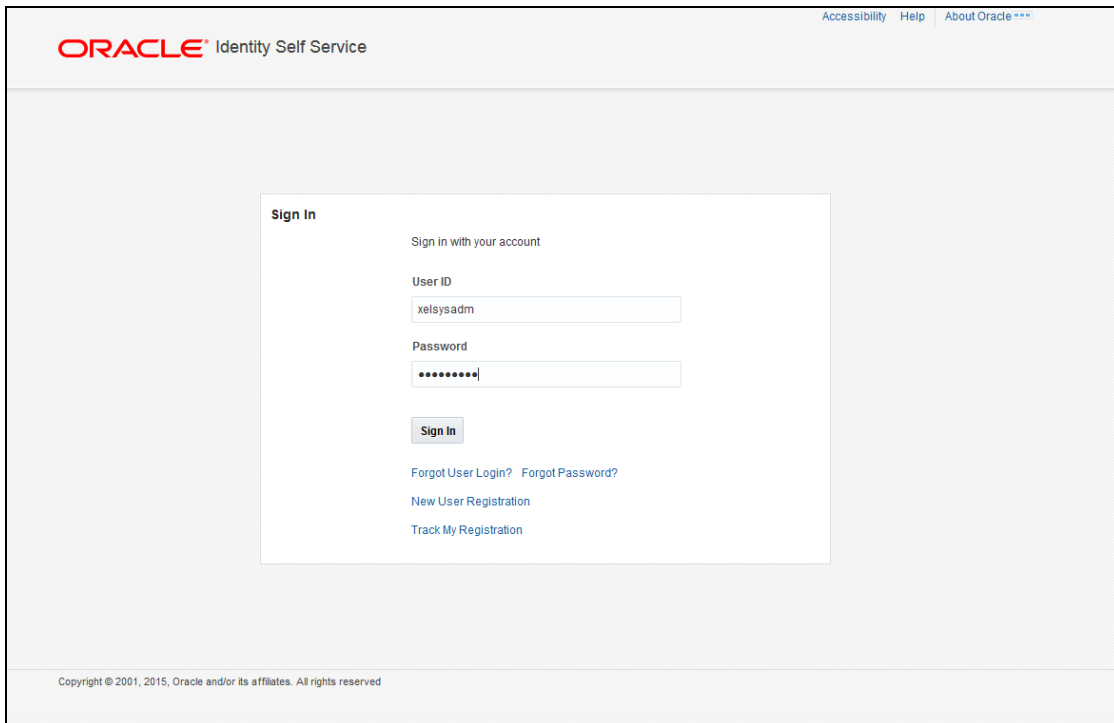

The screenshot shows the Oracle Identity Self Service Sign In page. The page header includes the Oracle logo and "Identity Self Service" text, along with links for "Accessibility", "Help", and "About Oracle ***". The main content area features a "Sign In" form with the following elements:

- Text: "Sign in with your account"
- Form field: "User ID" with the value "xelsysadm" entered.
- Form field: "Password" with masked characters "*****" entered.
- Button: "Sign In"
- Links: "Forgot User Login?", "Forgot Password?", "New User Registration", and "Track My Registration".

The footer contains the copyright notice: "Copyright © 2001, 2015, Oracle and/or its affiliates. All rights reserved."

6.1.1.2 Click on Users under Manage

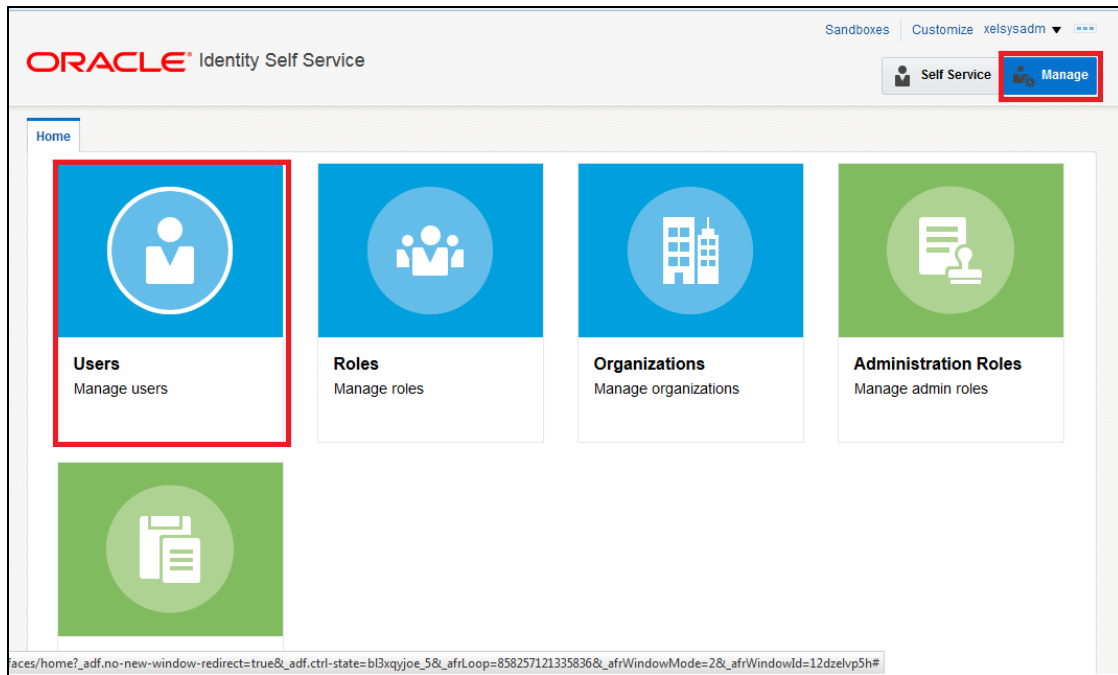

6.1.1.3 Click on Create

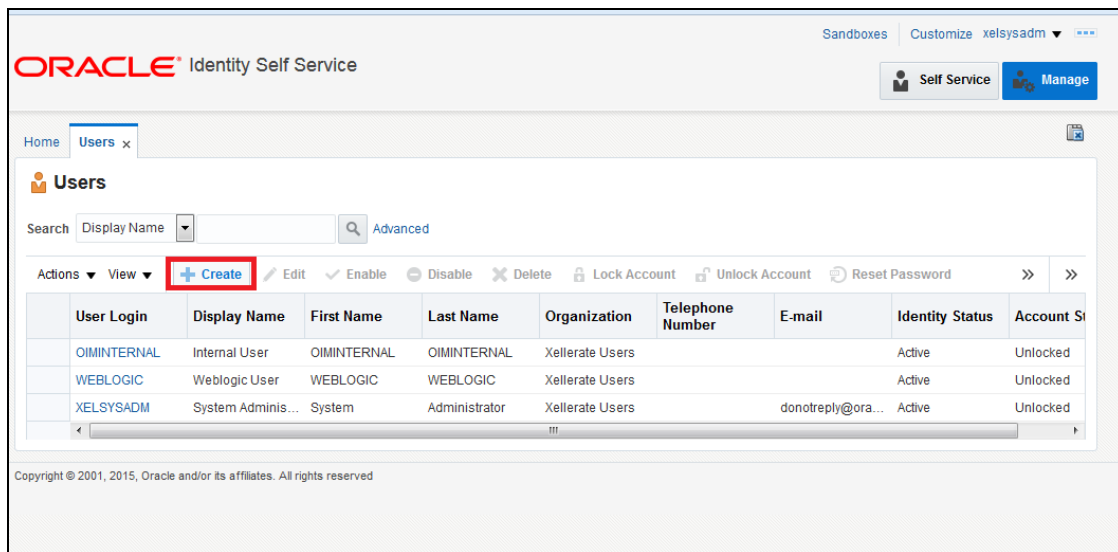

6.1.1.4 The Create User screen will get displayed

a. Below are the mandatory fields, which needs to be entered to Create the User in Oracle Identity Manager

- i. First Name
- ii. Last Name
- iii. Organization
- iv. User Type
- v. E-mail
- vi. Display Name
- vii. User Login
- viii. Password
- ix. Confirm Password
- x. Start Date

Note: Password and Confirm Password are not entered then System will generate some random password & it will mailed to the email address entered.

b. Click on Submit.

ORACLE Identity Self Service

Sandboxes Customize xelsysadm

Self Service Manage

Home Users x Create User x

Create User Submit Save As... Cancel

▶ Request Information

▲ Basic Information

First Name Nandhakumar Manager

Middle Name

* Last Name Vemban * Organization Requests

E-mail nandhakumarvemban@oracle.com * User Type Employee

Display Name Nandhakumar Vemban

▲ Account Settings

User Login nvemban-in

Password

* Confirm Password

▲ Account Effective Dates

Start Date 4/25/2016

End Date

▲ Provisioning Dates

6.1.1.5 On successful creation of user "User successfully got created" message will get appeared

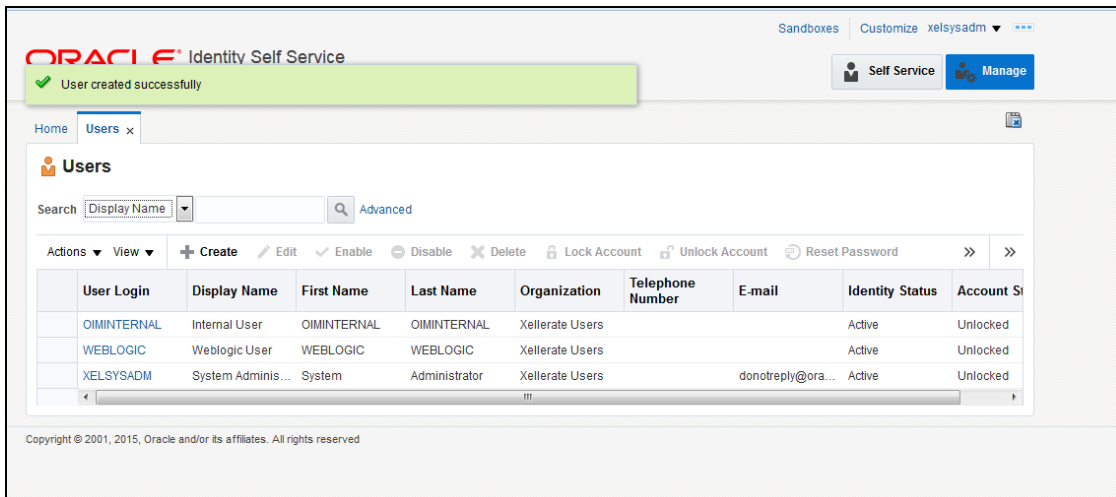

6.1.1.6 Click on Refresh to fetch the updated user list

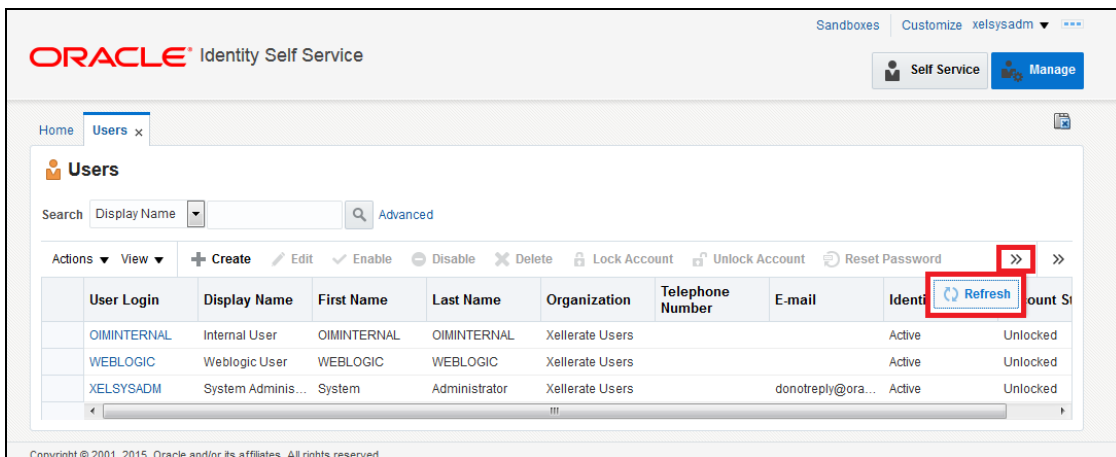

6.1.1.7 Click on the User created in the step above and Click on Accounts TAB

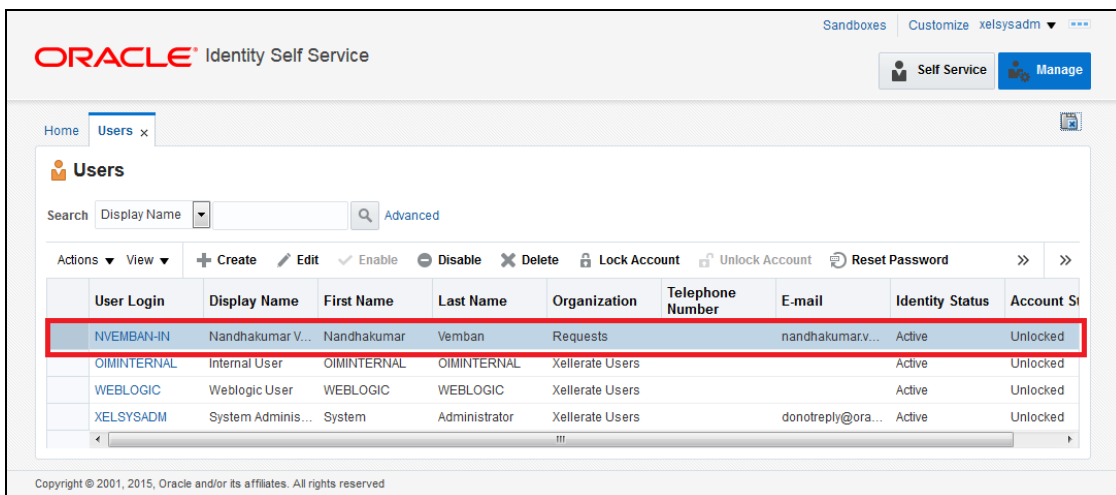

6.1.1.8 Wait for Time, which has been set to evaluate the user access policy in 5.1.6.2.2.15 and Click on Refresh. In the Accounts TAB, User will be provisioned with OID User Resource Type.

ORACLE Identity Self Service

Sandboxes Customize xelsysadm

Self Service Manage

Home Users x User Details : Nandhakuma... x

Nandhakumar Vemban

Modify Enable Disable Delete Lock Account UnLock Account Reset Password

Attributes Roles Entitlements **Accounts** Direct Reports Organizations Admin Roles

Actions View + Request Accounts Modify Grant Duration + Request Entitlement Refresh Resource History Detach

| Application Instance | Resource | Account Name | Provisioned On | Status | Account Type | Request ID | Start Date | End Date |
|----------------------|----------|--------------|----------------|-------------|--------------|------------|------------|----------|
| OID User | OID User | NVEMBAN-IN | 4/25/2016 | Provisioned | Primary | | 4/25/2016 | |

Copyright © 2001, 2015, Oracle and/or its affiliates. All rights reserved

6.1.1.9 Click on Request Accounts

ORACLE Identity Self Service

Sandboxes Customize xelsysadm

Self Service Manage

Home Users x User Details : Nandhakuma... x

Nandhakumar Vemban

Modify Enable Disable Delete Lock Account UnLock Account Reset Password

Attributes Roles Entitlements Accounts Direct Reports Organizations Admin Roles

Actions View + **Request Accounts** Modify Grant Duration + Request Entitlement Refresh Resource History Detach

| Application Instance | Resource | Account Name | Provisioned On | Status | Account Type | Request ID | Start Date | End Date |
|----------------------|----------|--------------|----------------|-------------|--------------|------------|------------|----------|
| OID User | OID User | NVEMBAN-IN | 4/25/2016 | Provisioned | Primary | | 4/25/2016 | |

Copyright © 2001, 2015, Oracle and/or its affiliates. All rights reserved

6.1.1.10 Click on **+ Add to Cart** against Oracle FLEXCUBE_GTC

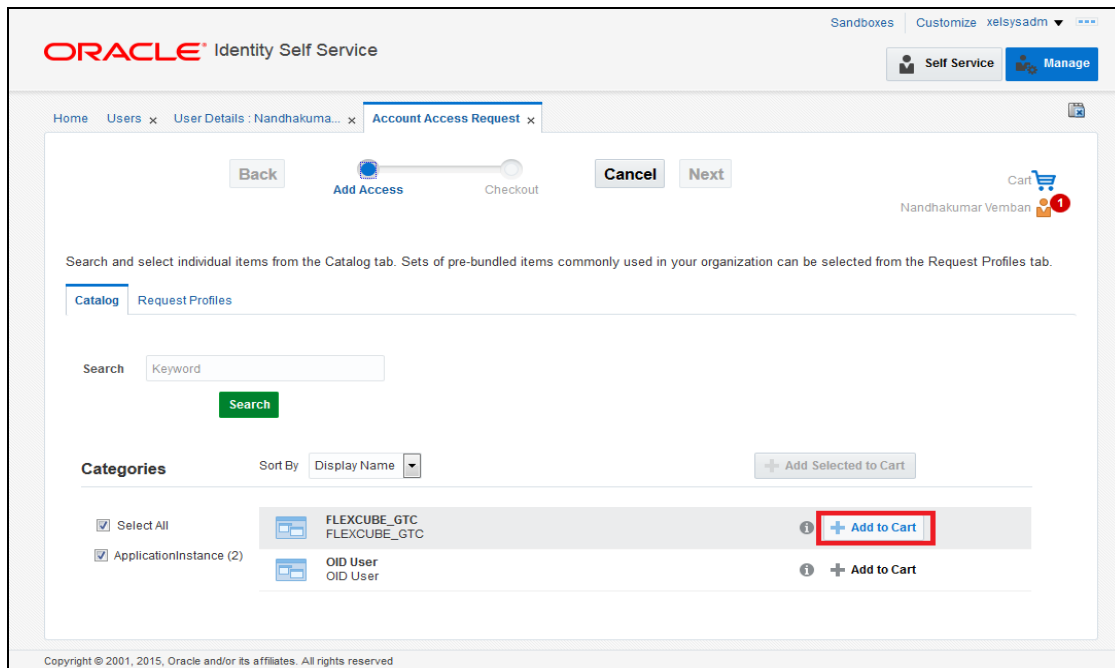

6.1.1.11 Click on Next Button

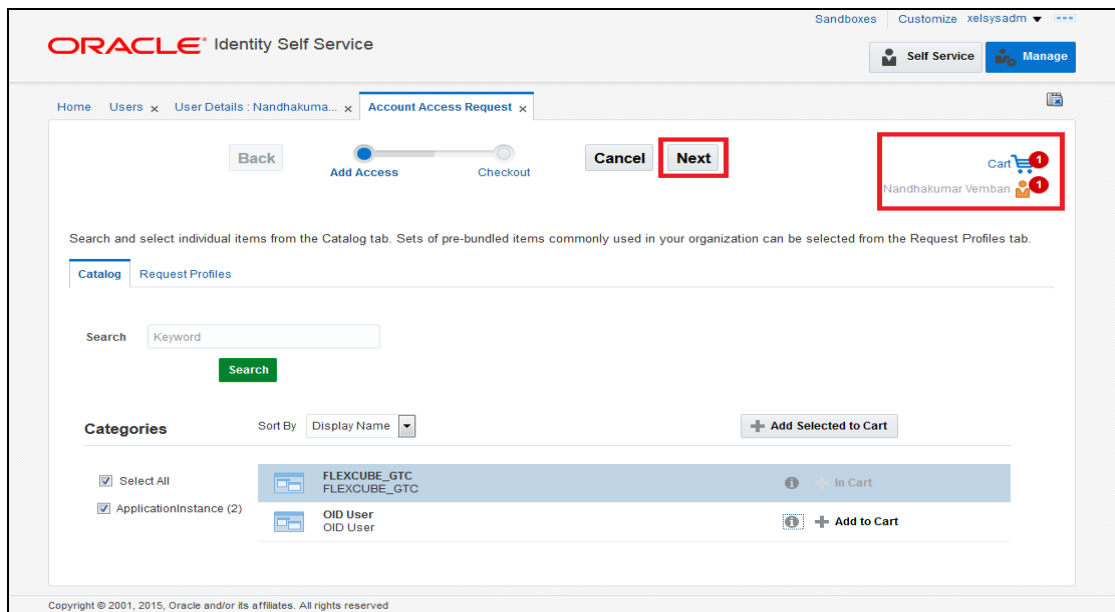

6.1.1.12 Following screen will appear like below:

- b. Click on Details form  to edit the user details
- c. Select the Home Branch, User Language, Time Level
- d. Click on Update Button

Note: In case like have a different Oracle FLEXCUBE USERID populated then it can be modified (only during Request Account in Oracle FLEXCUBE), do not modify any other value, which is pre-populated in this screen.

ORACLE Identity Self Service

Sandboxes Customize xelsysadm

Self Service Manage

Home Users x User Details : Nandhakuma... x Account Access Request x

Back Add Access Checkout Cancel Next Nandhakumar Vemban

Cart Details Submit Save As...

Request Information

Cart Items

Display Name FLEXCUBE_GTC FLEXCUBE_GTC

Request Details FLEXCUBE_GTC Update

Details

| | | | |
|--------------|--------------------|-----------------|------------------------------------|
| containerID | | USERLANGUAGE | ENG |
| ID | | TIMELEVEL | 9 |
| objectclass | | STARTDATE | 4/25/2016 |
| USERID | NVEMBAN-IN | EMAIL | nandhakumar.vemban@oracle.com |
| USERNAME | Nandhakumar Vemban | LDAPUSR | cn=NVEMBAN-IN,cn=Users,dc=ofss,dc= |
| USERPASSWORD | ***** | Service Account | <input type="checkbox"/> |
| HOMEBRANCH | 000 | | |

Copyright © 2001, 2015, Oracle and/or its affiliates. All rights reserved

6.1.1.13 Click on Submit

ORACLE Identity Self Service

Sandboxes Customize xelsysadm

Self Service Manage

Home Users x User Details : Nandhakuma... x Account Access Request x

Back Add Access Checkout Cancel Next Nandhakumar Vemban

Cart Details Submit Save As...

Request Information

Cart Items

Display Name FLEXCUBE_GTC FLEXCUBE_GTC

Request Details FLEXCUBE_GTC Update

Details

| | | | |
|--------------|--------------------|-----------------|------------------------------------|
| containerID | | USERLANGUAGE | ENG |
| ID | | TIMELEVEL | 9 |
| objectclass | | STARTDATE | 4/25/2016 |
| USERID | NVEMBAN-IN | EMAIL | nandhakumar.vemban@oracle.com |
| USERNAME | Nandhakumar Vemban | LDAPUSR | cn=NVEMBAN-IN,cn=Users,dc=ofss,dc= |
| USERPASSWORD | ***** | Service Account | <input type="checkbox"/> |
| HOMEBRANCH | 000 | | |

Copyright © 2001, 2015, Oracle and/or its affiliates. All rights reserved

6.1.1.14 Click on Refresh in Accounts TAB

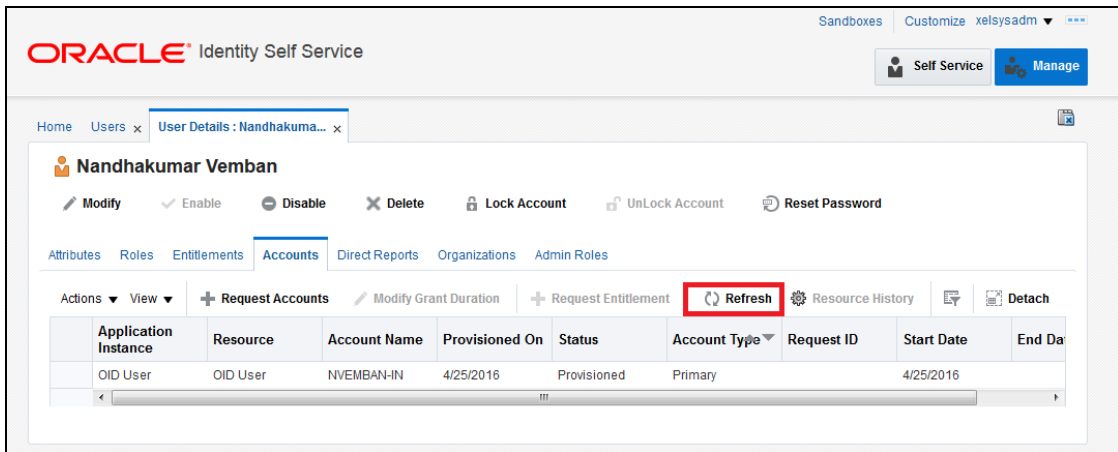

6.1.1.15 It will show the Requested Account and It's status

If the status is provisioned then the User is created in the Target Application.

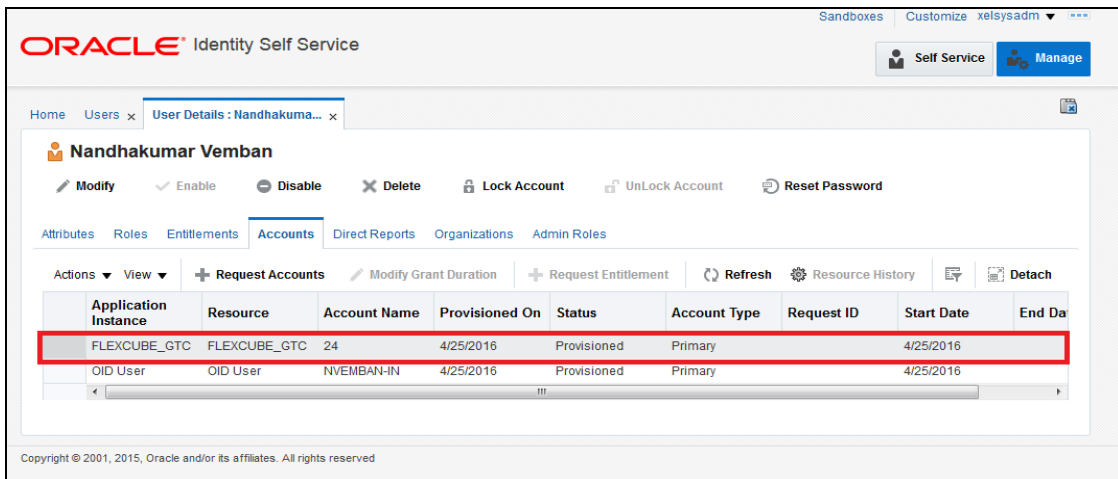

6.1.2 Modifying a user in FCIS through OIM

6.1.2.1 Navigate to the Accounts TAB>>Select FLEXCUBE_GTC >> Click on Modify Accounts.

- After successful provisioning User Details like User Name, User Password, Time Level, User Language and Home Branch can be modified.
- Email, LDAP User, Start Date should not be modified.

ORACLE Identity Self Service

Sandboxes Customize xelsysadm

Self Service Manage

Home Users x User Details : Nandhakuma... x

Nandhakumar Vemban

Modify Enable Disable Delete Lock Account Un.Lock Account Reset Password

Attributes Roles Entitlements **Accounts** Direct Reports Organizations Admin Roles

Actions View + Request Accounts **Modify Accounts** Modify Grant Duration Remove Accounts Make Primary >>

| Application Instance | Resource | Account Name | Provisioned On | Status | Account Type | Request ID | Start Date | End Date |
|----------------------|--------------|--------------|----------------|-------------|--------------|------------|------------|----------|
| FLEXCUBE_GTC | FLEXCUBE_GTC | 24 | 4/25/2016 | Provisioned | Primary | | 4/25/2016 | |
| OID User | OID User | NVEMBAN-IN | 4/25/2016 | Provisioned | Primary | | 4/25/2016 | |

6.1.2.2 The following screen is displayed

- Modify the data (Any/All of User Name, User Password, Time Level, Home Branch and User Language).
- Click on Update Button.
- Click on Submit.

ORACLE Identity Self Service

Sandboxes Customize xelsysadm

Self Service Manage

Home Users x User Details : Nandhakuma... x **Modify Account** x

Modify Account

Submit Save As...

Target Users

Name
Nandhakumar Vemban

Request Information

Cart Items

Display Name
24@FLEXCUBE_GTC
FLEXCUBE_GTC

Request Details 24@FLEXCUBE_GTC

Edit Account details

containerID _____ HOMEBRANCH 000

ID _____ USERLANGUAGE ENG

objectclass _____ TIMELEVEL 7

USERID NVEMBANIN STARTDATE 4/25/2016

USERNAME Nandhakumar Vemban EMAIL nandhakumarvemban@oracle.com

USERPASSWORD ***** LDAPUSR cn=NVEMBAN-IN,cn=Users,dc=ofss,dc=

Update

6.1.2.3 Navigate to the Accounts >> Select FLEXCUBE_GTC >> Resource History

The screenshot shows the Oracle Identity Self Service interface. At the top, it says 'ORACLE Identity Self Service' and 'xelsysadm'. The user 'Nandhakumar Vemban' is selected. The 'Accounts' tab is active, displaying a table with columns: Application Instance, Resource, Account Name, Provisioned On, Status, Account Type, and Request ID. Two accounts are listed: 'FLEXCUBE_GTC' (Account Name: 24, Provisioned On: 4/25/2016, Status: Provisioned, Account Type: Primary) and 'OID User' (Account Name: NVEMBAN-IN, Provisioned On: 4/25/2016, Status: Provisioned, Account Type: Primary). A context menu is open over the first account, with options: Enable, Disable, Refresh, Resource History (highlighted in red), and Reset Password.

6.1.2.4 The following screen is displayed

- Based on the modification done it will show the individual field change status (In case of more than one field like User Name, User Password changes it will show USERNAME Updated, HOMEBRANCH Updated etc.).

The screenshot shows the 'Resource Provisioning Details' page. The breadcrumb is 'User Detail >> Resource Profile >> Resource Provisioning Details'. Below the breadcrumb, it says 'The following are the provisioning tasks for the resource. You can also enable, disable, or revoke this resource from the user.' The resource is 'FLEXCUBE_GTC' for user 'Nandhakumar Vemban[NVEMBAN-IN]'. The table shows 4 results, all completed tasks assigned to 'System Administrator [XELSYSADM]':

| Task Name | Task Status | Date Assigned | Assigned To | Retry |
|-------------------|-------------|----------------|----------------------------------|--------------------------|
| TIMELEVEL Updated | Completed | April 25, 2016 | System Administrator [XELSYSADM] | <input type="checkbox"/> |
| Create User | Completed | April 25, 2016 | System Administrator [XELSYSADM] | <input type="checkbox"/> |
| System Validation | Completed | April 25, 2016 | System Administrator [XELSYSADM] | <input type="checkbox"/> |

At the bottom, there are 'Exit' and 'Add Task' buttons, and a 'Retry' button.

6.1.3 Disable/Remove Accounts in FCIS through OIM

There is a slight difference between Disable and Remove Accounts option. If the account disabled then the same account can be enabled using the Enable option. If the account is Removed then the account cannot be enabled through OIM. But in FCIS, both Disable and Remove option will close the existing user record.

Remove Accounts will show the Last Known Status

6.1.3.1 Accounts>>Select FLEXCUBE_GTC >>Click on Disable/Remove Accounts

The screenshot shows the Oracle Identity Self Service interface for user Nandhakumar Vemban. The 'Accounts' tab is selected, displaying a table with columns: Application Instance, Resource, Account Name, Provisioned On, Status, Account Type, and Request. Two accounts are listed: FLEXCUBE_GTC (Account Name: 24) and OID User (Account Name: NVEMBAN-IN). The 'Remove Accounts' button is highlighted in red. A dropdown menu is open, showing the 'Disable' button also highlighted in red. Below the table, the 'Detail Information' for the selected account is visible.

| Application Instance | Resource | Account Name | Provisioned On | Status | Account Type | Request |
|----------------------|--------------|--------------|----------------|-------------|--------------|---------|
| FLEXCUBE_GTC | FLEXCUBE_GTC | 24 | 4/25/2016 | Provisioned | Primary | |
| OID User | OID User | NVEMBAN-IN | 4/25/2016 | Provisioned | Primary | |

6.1.3.2 Disable Confirmation Screen will get displayed

b. Click on Submit.

The screenshot shows the 'Disable Accounts' confirmation screen in Oracle Identity Self Service. The 'Target Users' section shows the user Nandhakumar Vemban. The 'Cart Items' section shows the account 24@FLEXCUBE_GTC. The 'Submit' button is highlighted in red.

6.1.3.3 Go to Accounts Tab and Click on Refresh

- a. On successful processing, it will display the FLEXCUBE_GTC status as Disabled.

The screenshot shows the Oracle Identity Self Service interface for user Nandhakumar Vemban. The 'Accounts' tab is active, displaying a table of application instances. The first row, representing the FLEXCUBE_GTC account, is highlighted with a red border. The table columns are: Application Instance, Resource, Account Name, Provisioned On, Status, Account Type, Request ID, Start Date, and End Date.

| Application Instance | Resource | Account Name | Provisioned On | Status | Account Type | Request ID | Start Date | End Date |
|----------------------|--------------|--------------|----------------|-------------|--------------|------------|------------|----------|
| FLEXCUBE_GTC | FLEXCUBE_GTC | 24 | 4/25/2016 | Disabled | Primary | | 4/25/2016 | |
| OID User | OID User | NVEMBAN-IN | 4/25/2016 | Provisioned | Primary | | 4/25/2016 | |

6.1.4 Enabling a Disabled user in FCIS through OIM

6.1.4.1 Accounts>>Select FLEXCUBE_GTC >>Click on Enable

The screenshot shows the Oracle Identity Self Service interface for user Nandhakumar Vemban. The 'Accounts' tab is active, and a context menu is open over the FLEXCUBE_GTC account row. The 'Enable' option is highlighted with a red box. The context menu options are: Request Entitlement, Enable, Disable, Refresh, Resource History, and Reset Password.

6.1.4.2 Enable Confirmation Screen will get displayed and Click on Submit

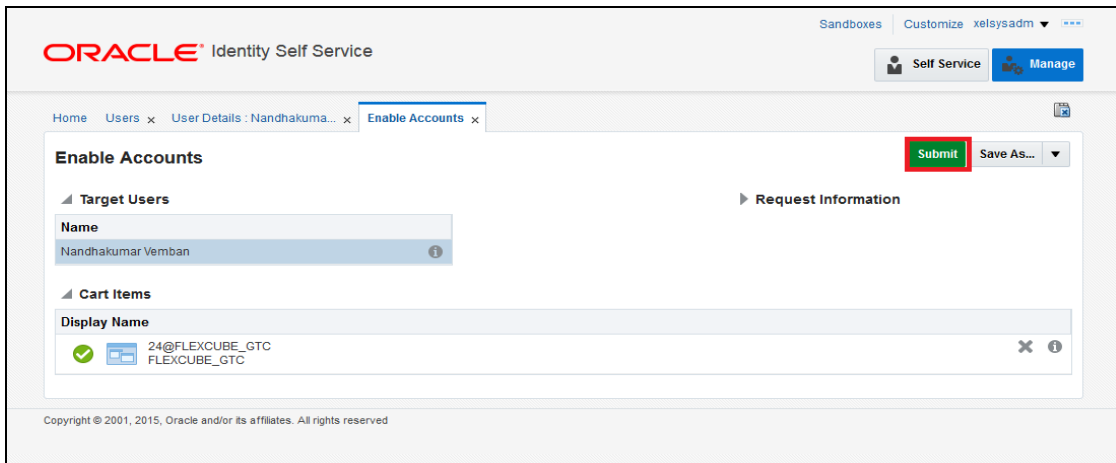

6.1.4.3 Go to Accounts TAB and Click on Refresh

- a. On successful processing, it will display Oracle FLEXCUBE_GTC status as Enabled.

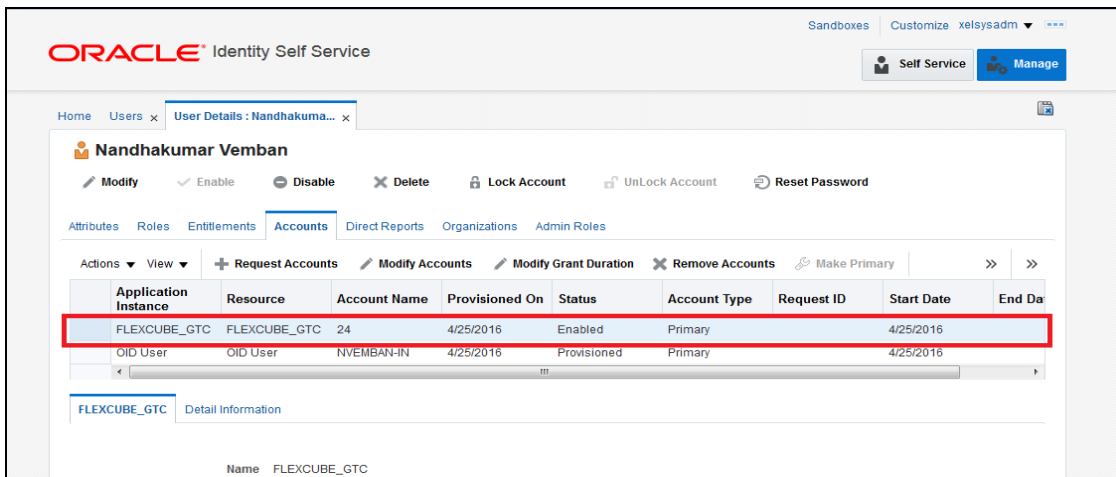

6.1.5 Running Reconciliation in OIM

Copy the reconciliation staging file that is created by function id SMBOIMHF as EOD day activity to the OIM server's staging directory.

6.1.5.1 Login to OIM Admin Console and Click on Scheduler under System Management



6.1.5.2 Under System Management tab and search for FLEXCUBE_GTC Scheduled Job by clicking Search Button

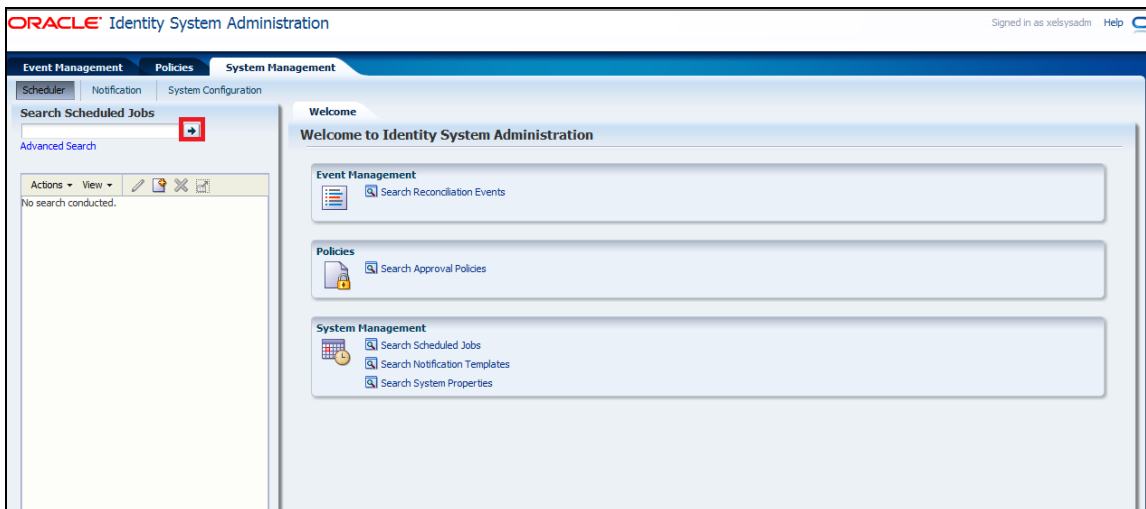

- a. If the job is scheduled periodically, based on the frequency and scheduled time, system will automatically process the reconciliation. If it not scheduled, user can manually initiate the reconciliation process by clicking the Run Now button.

- b. After running the process, click Refresh button to view the status of the initiated job. The job history section available in the screen will show whether the job is in progress or it is completed.

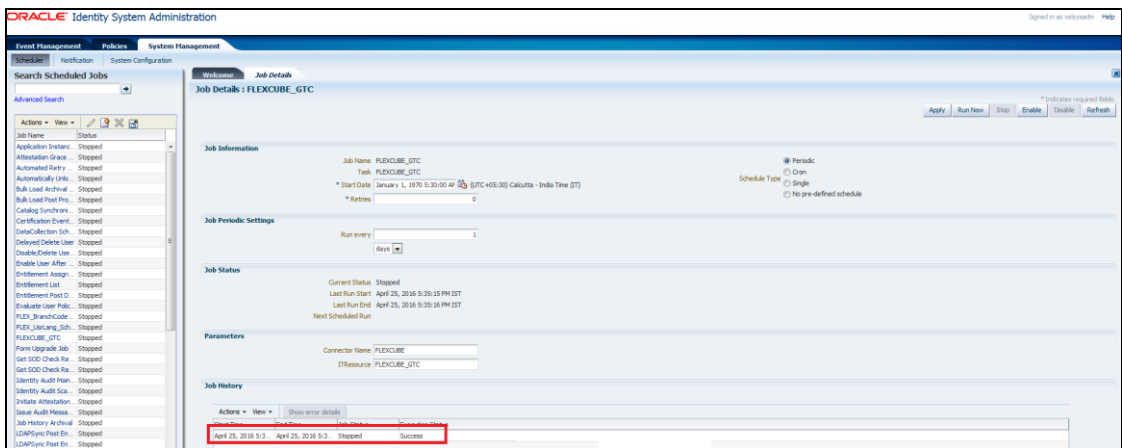
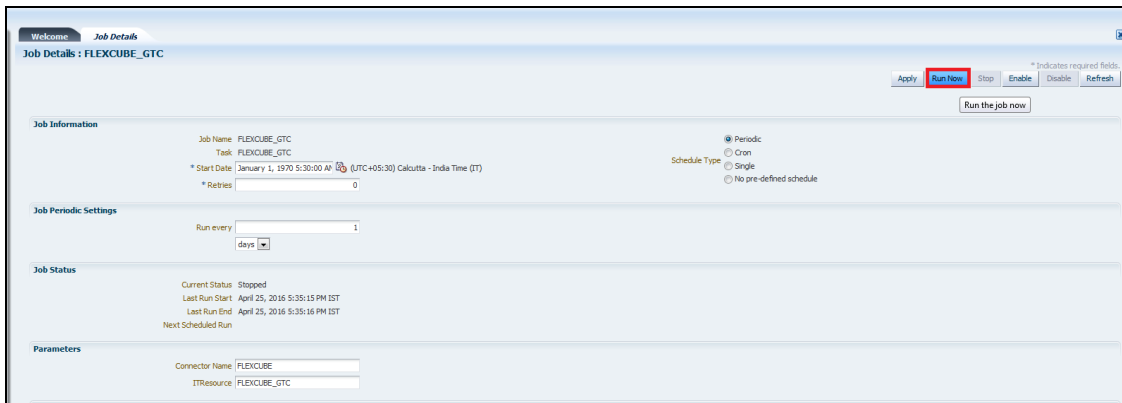
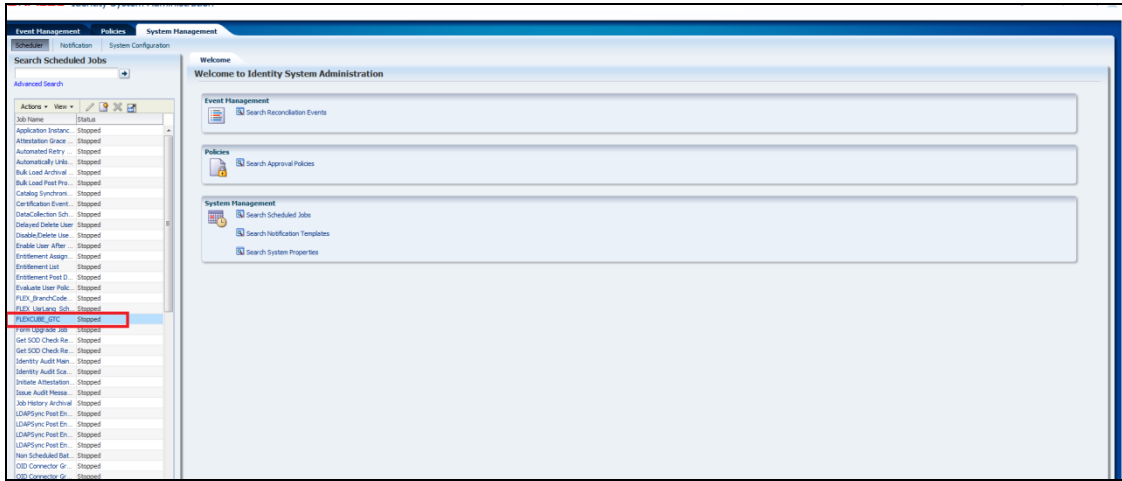

6.1.5.3 To Check the Status of Reconciliation Process, Click on Event Management Tab and Click the Search button and Click on the Latest Event ID. The screen will show the reconciliation data and the user ID matched for the reconciliation.

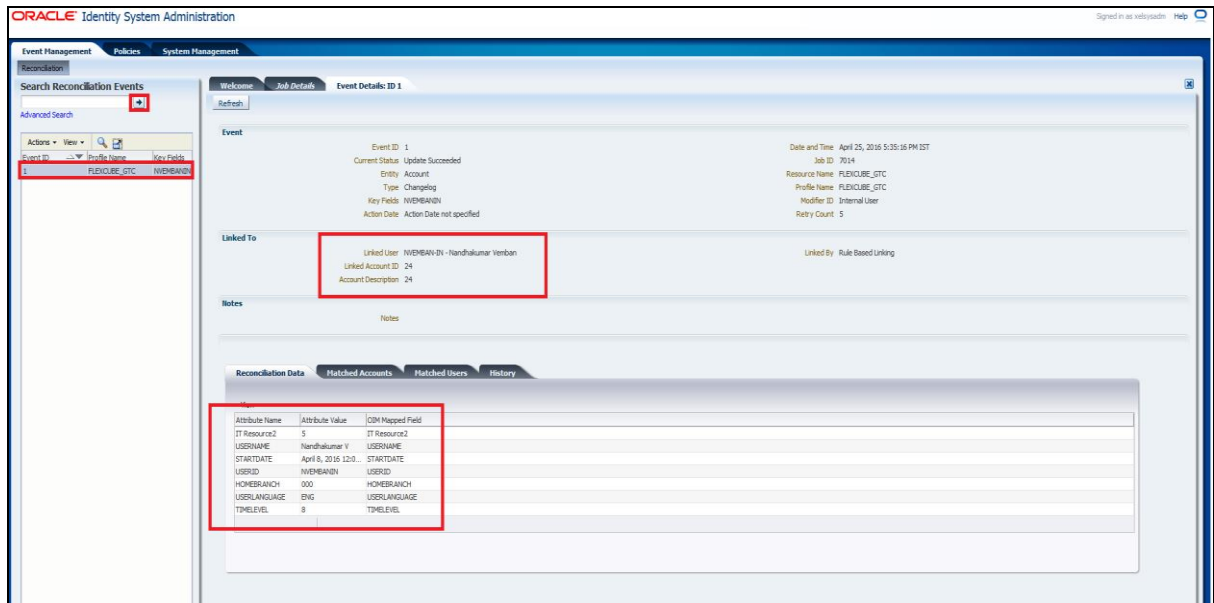

In the Event details screen

- Check the Status: If it is "Update Succeeded" then it means the reconciliation process was able to find a matching user. It also shows the reconciliation data that has been affected.
- If the Liked User is "Not Licked to any user" then it means the reconciliation process was not able to find a matching user.

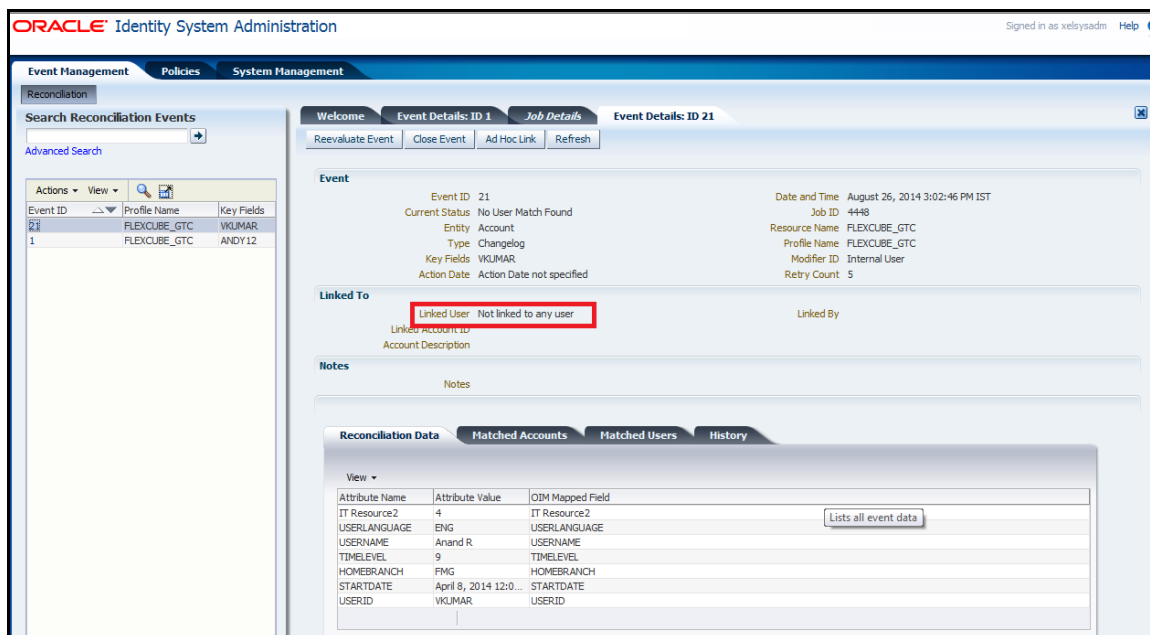

7. Reference

| Document Number | Title |
|-----------------|---|
| 1 | Oracle Identity Manager Document. |
| 2 | SPML specification Document. |

8. Appendix

8.1 Data Source Creation

1. Open the application server console in the browser by typing Console URL of Weblogic application server

<http://<hostname>:<port>/console/>

2. Login to Administrative Console
3. Enter Weblogic administrator username/password and press Login.



4. Expand Services and click on Data Sources as shown in below screen:

| Name | Type | JNDI Name | Targets |
|----------------------|---------|---------------------------|--------------------------------|
| EDNDataSource | Generic | jdbc/EDNDataSource | soa_server1 |
| EDNLocalTxDataSource | Generic | jdbc/EDNLocalTxDataSource | soa_server1 |
| fgDevDS | Generic | jdbc/fgDevDS | Applications |
| fgDevDS11 | Generic | jdbc/fgDevDS11 | Applications |
| fgDevDS120 | Generic | jdbc/fgDevDS120 | Applications |
| FCUBS | Generic | jdbc/fgDevDS | AdminServer, Applications |
| FCUBS120_XA | Generic | jdbc/fgDevDS120_XA | Applications |
| FCUBSScheduler | Generic | jdbc/fgSchedulerDS | Applications |
| jdbc/registryDS | Generic | jdbc/registryDS | wls_ods1, wls_of1, oas_server1 |
| mids-aim | Generic | jdbc/mids/MDS_REPOS | aim_server1 |

5. Click on Lock & Edit as shown below.

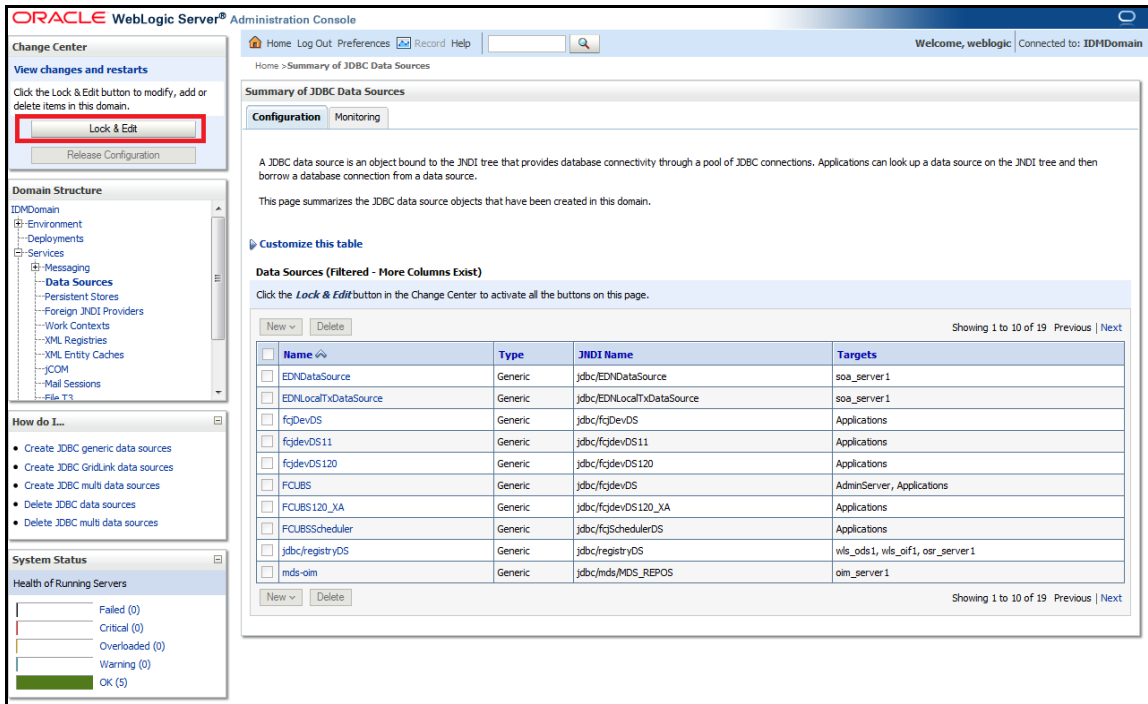

6. Expand New and click on Generic Data Source.

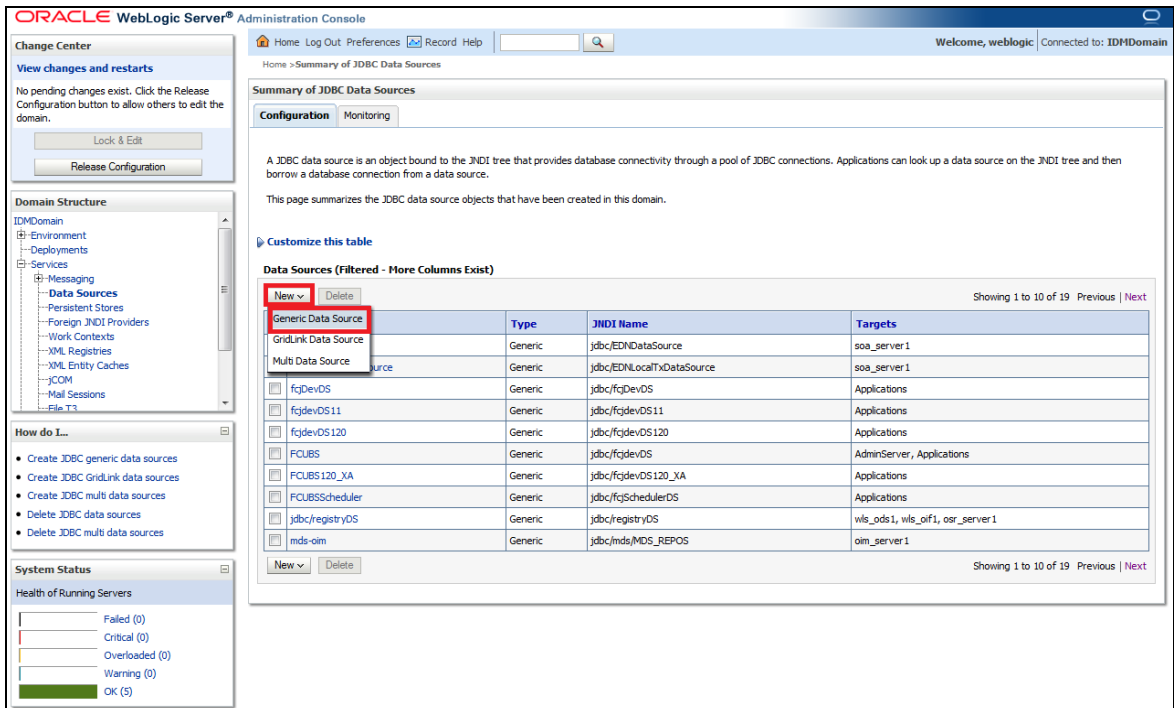

The following screen will get displayed.

Enter the Data Source Name and JNDI Name as mentioned in the <FCIS Release Name>\ADAPTERS\OIM\FCUBSLOVAdService\config\lookup_prop.xml → value of the key FCUBS_CON_POOLNAME.

For example value of the key FCUBS_CON_POOLNAME is OIM then:

Name OIM
JNDI Name jdbc/OIM
Database Type Oracle

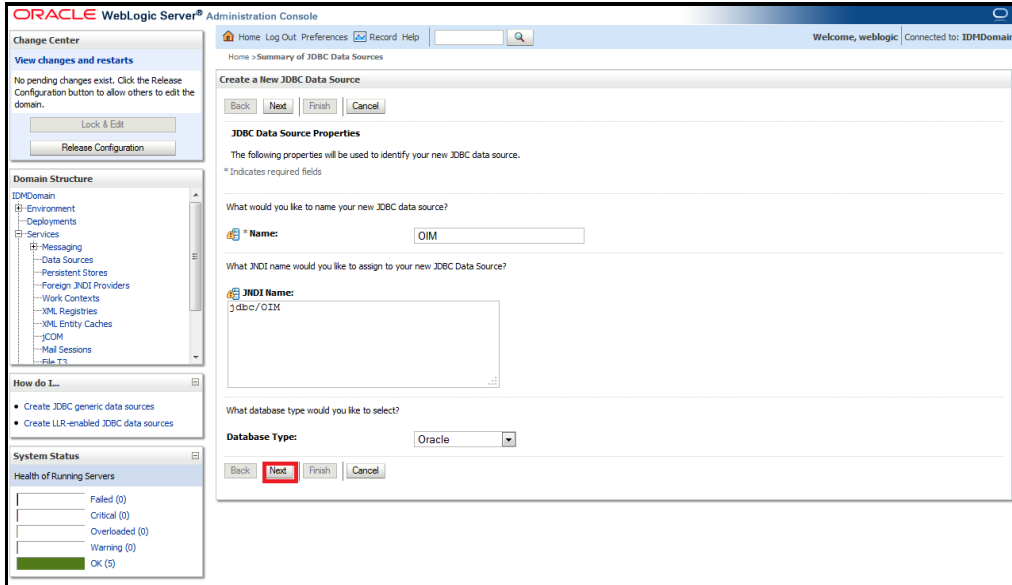

The following screen will get displayed. Select Database Driver as Oracle's Driver (Thin) for Instance connections: Versions 9.0.1 and later. Click on Next.

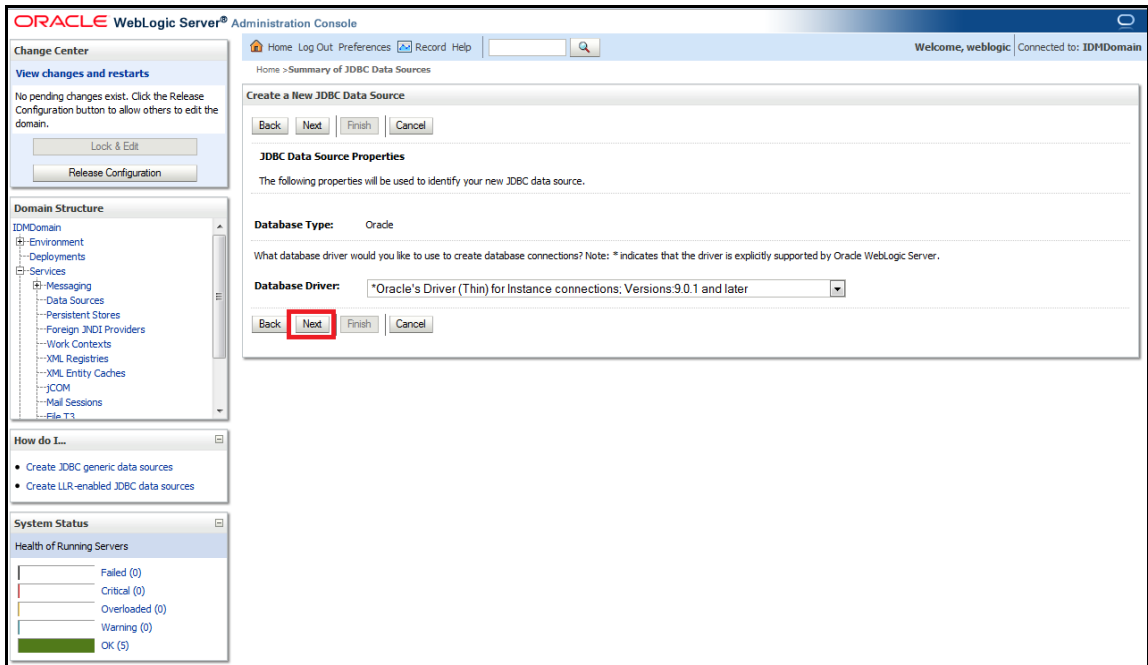

We get the following screen in which un-check Supports Global Transactions and click on Next.

ORACLE WebLogic Server® Administration Console

Home Log Out Preferences Record Help

Welcome, weblogic Connected to: IDMDomain

Home > Summary of JDBC Data Sources

Create a New JDBC Data Source

Back Next Finish Cancel

Transaction Options

You have selected non-XA JDBC driver to create database connection in your new data source.

Does this data source support global transactions? If yes, please choose the transaction protocol for this data source.

Supports Global Transactions

Select this option if you want to enable non-XA JDBC connections from the data source to participate in global transactions using the *Logging Last Resource (LR)* transaction optimization. Recommended in place of Emulate Two-Phase Commit.

Logging Last Resource

Select this option if you want to enable non-XA JDBC connections from the data source to emulate participation in global transactions using JTA. Select this option only if your application can tolerate heuristic conditions.

Emulate Two-Phase Commit

Select this option if you want to enable non-XA JDBC connections from the data source to participate in global transactions using the one-phase commit transaction processing. With this option, no other resources can participate in the global transaction.

One-Phase Commit

Back Next Finish Cancel

The following screen will get displayed. Enter the Database Name, Host Name, Port, Database User Name, Password and Confirm Password. Click on Next.

ORACLE WebLogic Server® Administration Console

Home Log Out Preferences Record Help

Welcome, weblogic Connected to: IDMDomain

Home > Summary of JDBC Data Sources

Create a New JDBC Data Source

Back Next Finish Cancel

Connection Properties

Define Connection Properties.

What is the name of the database you would like to connect to?

Database Name:

What is the name or IP address of the database server?

Host Name:

What is the port on the database server used to connect to the database?

Port:

What database account user name do you want to use to create database connections?

Database User Name:

What is the database account password to use to create database connections?

Password:

Confirm Password:

Back Next Finish Cancel

The following screen will get displayed. Click on 'Test Configuration'.

It will display “Connection test succeeded” as shown below. If it is not getting displayed then verify the correctness of all data source properties entered. Click on Finish button.

ORACLE WebLogic Server® Administration Console

Home > Summary of JDBC Data Sources

Messages

✔ Connection test succeeded.

Create a New JDBC Data Source

Test Configuration Back Next Finish Cancel

Test Database Connection

Test the database availability and the connection properties you provided.

What is the full package name of JDBC driver class used to create database connections in the connection pool?
(Note that this driver class must be in the classpath of any server to which it is deployed.)

Driver Class Name: oracle.jdbc.OracleDriver

What is the URL of the database to connect to? The format of the URL varies by JDBC driver.

URL: jdbc:oracle:thin:@10.11

What database account user name do you want to use to create database connections?

Database User Name: DAY0114

What is the database account password to use to create database connections?
(Note: for secure password management, enter the password in the Password field instead of the Properties field below)

Password:

Confirm Password:

What are the properties to pass to the JDBC driver when creating database connections?

Properties:
use=DAY0114

The set of driver properties whose values are derived at runtime from the named system property.

The following screen will get displayed. Click on Activate Changes.

ORACLE WebLogic Server® Administration Console

Home > Summary of JDBC Data Sources

Summary of JDBC Data Sources

Configuration Monitoring

A JDBC data source is an object bound to the JNDI tree that provides database connectivity through a pool of JDBC connections. Applications can look up a data source on the JNDI tree and then borrow a database connection from a data source.

This page summarizes the JDBC data source objects that have been created in this domain.

Customize this table

Data Sources (Filtered - More Columns Exist)

New Delete Showing 1 to 10 of 20 Previous Next

| Name | Type | JNDI Name | Targets |
|----------------------|---------|---------------------------|--------------------------------|
| EDNDataSource | Generic | jdbc/EDNDataSource | soa_server1 |
| EDNLocalTxDataSource | Generic | jdbc/EDNLocalTxDataSource | soa_server1 |
| fcjDevDS | Generic | jdbc/fcjDevDS | Applications |
| fcjDevDS11 | Generic | jdbc/fcjDevDS11 | Applications |
| fcjDevDS120 | Generic | jdbc/fcjDevDS120 | Applications |
| FCUBS | Generic | jdbc/fcjDevDS | AdminServer, Applications |
| FCUBS120_XA | Generic | jdbc/fcjDevDS120_XA | Applications |
| FCUBSScheduler | Generic | jdbc/fcjSchedulerDS | Applications |
| jdbc/registryDS | Generic | jdbc/registryDS | wls_ods1, wls_of1, osr_server1 |
| mds-aim | Generic | jdbc/mds/MDS_REPOS | aim_server1 |

New Delete Showing 1 to 10 of 20 Previous Next



Oracle Identity Manager Integration Implementation Guide
[February] [2022]
Version 14.5.3.0.0

Oracle Financial Services Software Limited
Oracle Park
Off Western Express Highway
Goregaon (East)
Mumbai, Maharashtra 400 063
India

Worldwide Inquiries:
Phone: +91 22 6718 3000
Fax: +91 22 6718 3001
www.oracle.com/financialservices/

Copyright © [2007], [2022], Oracle and/or its affiliates.

Oracle and Java are registered trademarks of Oracle and/or its affiliates. Other names may be trademarks of their respective owners.

U.S. GOVERNMENT END USERS: Oracle programs (including any operating system, integrated software, any programs embedded, installed or activated on delivered hardware, and modifications of such programs) and Oracle computer documentation or other Oracle data delivered to or accessed by U.S. Government end users are "commercial computer software" or "commercial computer software documentation" pursuant to the applicable Federal Acquisition Regulation and agency-specific supplemental regulations. As such, the use, reproduction, duplication, release, display, disclosure, modification, preparation of derivative works, and/or adaptation of i) Oracle programs (including any operating system, integrated software, any programs embedded, installed or activated on delivered hardware, and modifications of such programs), ii) Oracle computer documentation and/or iii) other Oracle data, is subject to the rights and limitations specified in the license contained in the applicable contract. The terms governing the U.S. Government's use of Oracle cloud services are defined by the applicable contract for such services. No other rights are granted to the U.S. Government.

This software or hardware is developed for general use in a variety of information management applications. It is not developed or intended for use in any inherently dangerous applications, including applications that may create a risk of personal injury. If you use this software or hardware in dangerous applications, then you shall be responsible to take all appropriate failsafe, backup, redundancy, and other measures to ensure its safe use. Oracle Corporation and its affiliates disclaim any liability for any damages caused by use of this software or hardware in dangerous applications.

This software and related documentation are provided under a license agreement containing restrictions on use and disclosure and are protected by intellectual property laws. Except as expressly permitted in your license agreement or allowed by law, you may not use, copy, reproduce, translate, broadcast, modify, license, transmit, distribute, exhibit, perform, publish or display any part, in any form, or by any means. Reverse engineering, disassembly, or decompilation of this software, unless required by law for interoperability, is prohibited.

The information contained herein is subject to change without notice and is not warranted to be error-free. If you find any errors, please report them to us in writing.

This software or hardware and documentation may provide access to or information on content, products and services from third parties. Oracle Corporation and its affiliates are not responsible for and expressly disclaim all warranties of any kind with respect to third-party content, products, and services. Oracle Corporation and its affiliates will not be responsible for any loss, costs, or damages incurred due to your access to or use of third-party content, products, or services.